

# **ATTRACTIVE DESIGN APPROACHES FOR A COMPACT STELLARATOR POWER PLANT**

---

**A. R. Raffray (University of California, San Diego)**

**L. El-Guebaly (University of Wisconsin, Madison)**

**S. Malang (Fusion Nuclear Technology Consulting)**

**X. Wang (University of California, San Diego)**

**and the ARIES Team**

**Presented at the 16th ANS TOFE**

**Madison, WI**

**September 14-16, 2004**



# Outline

---

- **Objectives of ARIES-CS study**
- **Engineering plan of action**
- **Maintenance approaches**
- **Blanket designs**
- **Summary**



# ARIES-CS Program Objective

---

- **Assessment of Compact Stellarator option as a power plant to help:**
  - **Advance physics and technology of CS concept and address concept attractiveness issues in the context of power plant studies**
  - **Identify optimum CS configuration for power plant**
    - **NCSX plasma/coil configuration as starting point**
    - **But optimum plasma/coil configuration for a power plant may be different**



# ARIES-CS Program is a Three-Phase Study

## Phase I: Development of Plasma/coil Configuration Optimization Tool

1. Develop physics requirements and modules (power balance, stability,  $\alpha$  confinement, divertor, *etc.*)
2. Develop engineering requirements and constraints through scoping studies.
3. Explore attractive coil topologies.

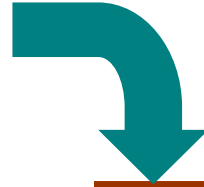

## Phase II: Exploration of Configuration Design Space

1. Physics:  $\beta$ , aspect ratio, number of periods, rotational transform, shear, *etc.*
2. Engineering: configuration optimization through more detailed studies of selected concepts
3. Choose one configuration for detailed design.



## Phase III: Detailed system design and optimization



# Engineering Activities During Phase I of ARIES-CS Study

- Perform Scoping Assessment of Different Maintenance Schemes and Blanket Concepts for Down Selection to a Couple of Combinations for Phase II

- Three Possible Maintenance Schemes:

1. Field-period based replacement including disassembly of modular coil system (e.g. SPPS, ASRA-6C)
2. Replacement of blanket modules through a few ports (using articulated boom)
3. Replacement of blanket modules through ports arranged between each pair of adjacent modular coils (e.g. HSR)

- Different Blanket Classes

1. Self-cooled Pb-17Li blanket with  $\text{SiC}_f/\text{SiC}$  as structural material
2. Dual-Coolant blanket with He-cooled FS structure and self-cooled LM (Li or Pb-17Li)
3. He-cooled CB blanket with FS structure
4. Flibe blanket with advanced FS

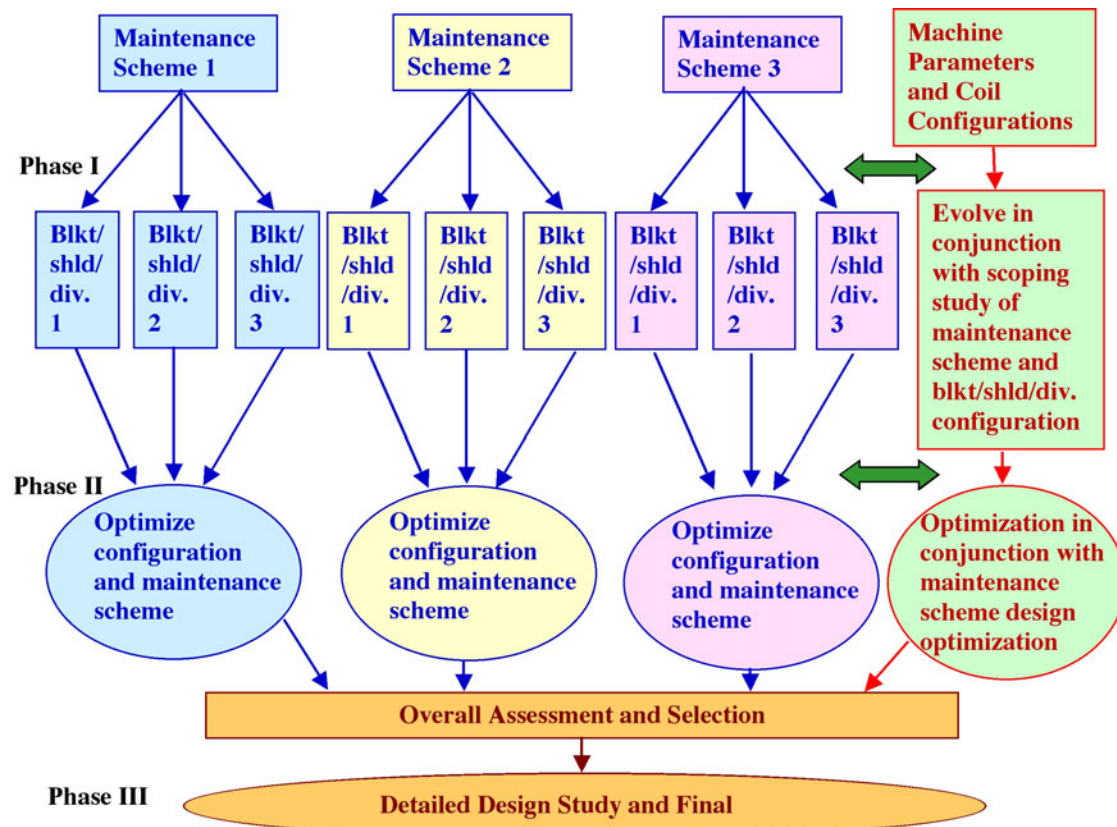

# Initial Configurations for ARIES-CS Phase I Scoping Studies

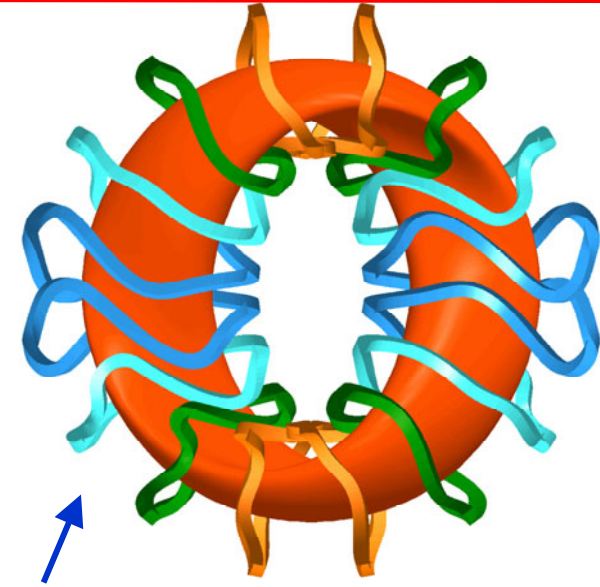
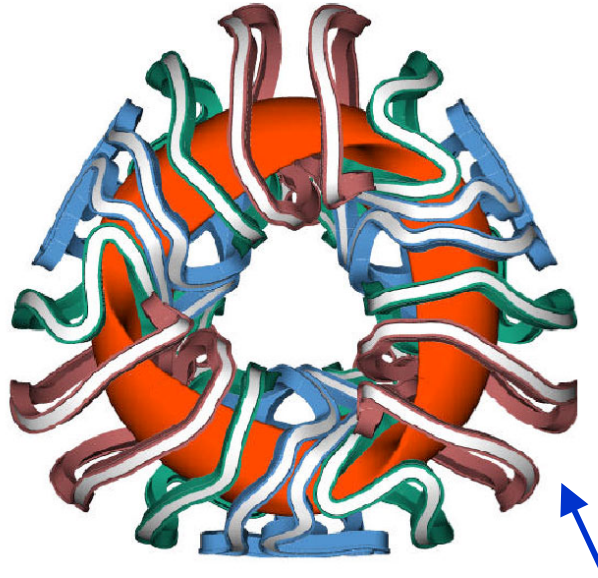

Parameter	3-field period (NCSX)	2-field period (MHH2)
Coil-plasma distance, $\Delta$ (m)	1.2	1.4
$\langle R \rangle$ (m)	8.3	7.5
$\langle a \rangle$ (m)	1.85	2.0
Aspect ratio	4.5	3.75
$\beta$ (%)	4.1	4.0
Number of coils	18	16*
$B_0$ (T)	5.3	5.0
$B_{max}$ (T)	14.4	14.4
Fusion power (GW)	2	2
Avg. wall load (MW/m <sup>2</sup> )	2.0	2.7

Se \*Cases of 12 and 8 coils also considered for 2-field period configuration.



# Scoping Study of Maintenance Schemes\*

**\*X. Wang, S. Malang, A. R. Raffray and the ARIES Team, “Maintenance Approaches for ARIES-CS Power,” poster presentation at 16<sup>th</sup> TOFE, P-I-28**



# Enclose the Individual Cryostats in a Common External Vacuum Vessel for Field-Based Maintenance Scheme

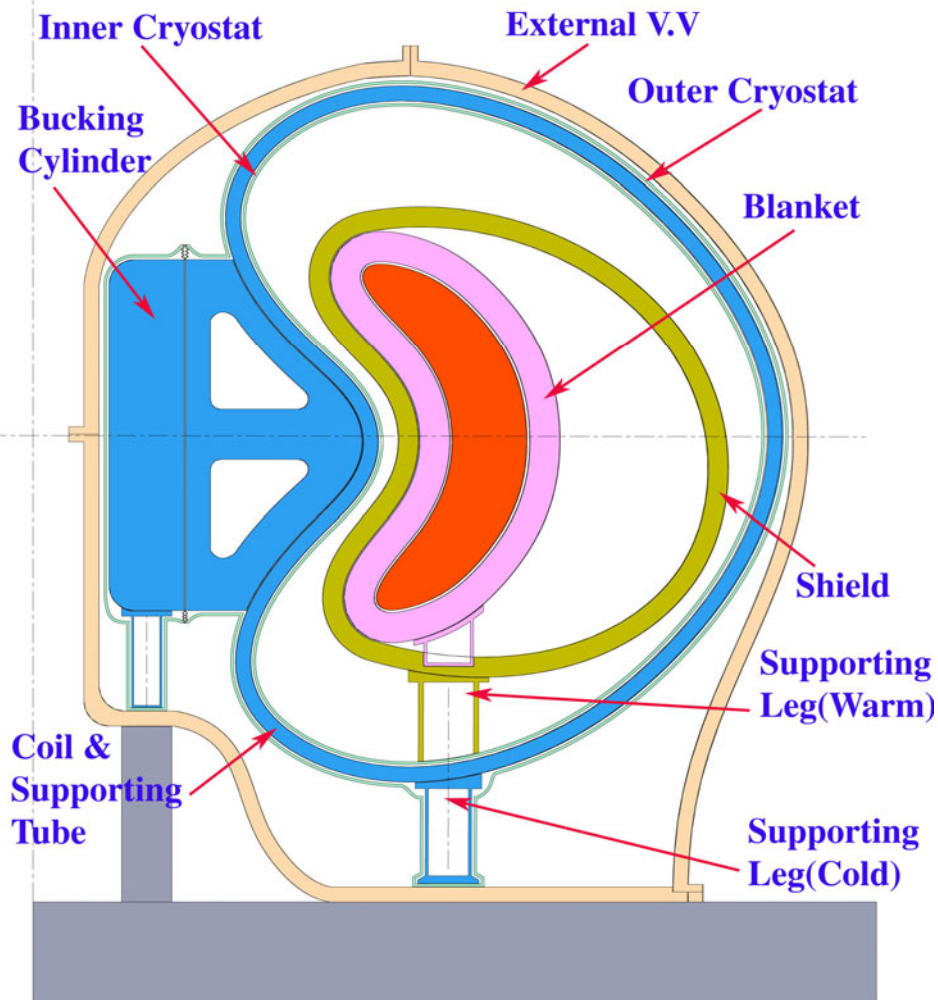

**Cross section of 3 field-period configuration at 0° illustrating the layout for field-period based maintenance.**

- The radial movement of a field period for blanket replacement should be possible without disassembling coils in order to avoid unacceptably long down time.
- To facilitate opening of the coil system for maintenance, separate cryostats for the bucking cylinder in the centre of the torus and for every field period are envisaged.
- Large centering forces need to be reacted by strong bucking cylinder.
- Transfer of large forces within a field period and between coils and bucking cylinder is not possible between “cold” and “warm” elements. This means that the entire support structure is operated at cryogenic temperature.





# Proposed Coil Structure for Field-Period Based Maintenance Scheme

- **Need to Design Coil Support Structure to Accommodate Forces**
  - No net forces between coils from one field period to the other.
  - Out-of plane forces acting between neighbouring coils inside a field period require strong inter-coil structure.
  - Weight of the cold coil system has to be transferred to the “warm” foundation without excessive heat ingress.
- **Field-period maintenance provides advantage of nearly no weight limit on blanket (use of air cushions)**
- **However, better suited for 3-field period or more because of scale of field period unit movement**

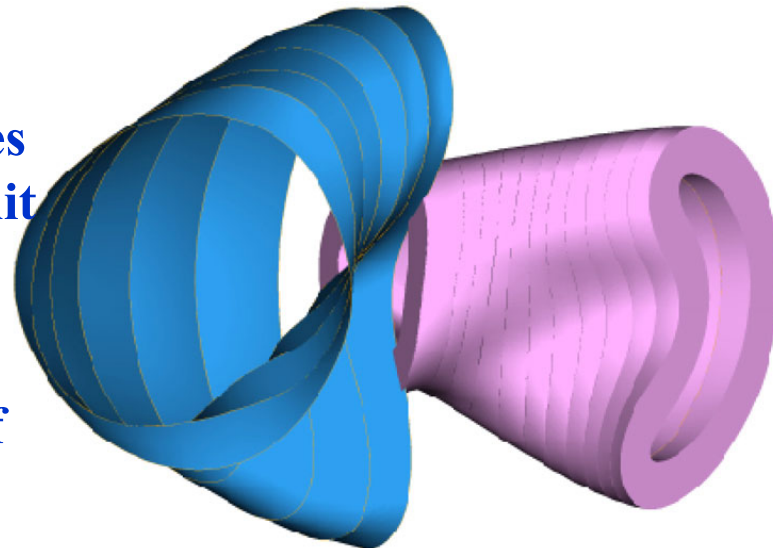
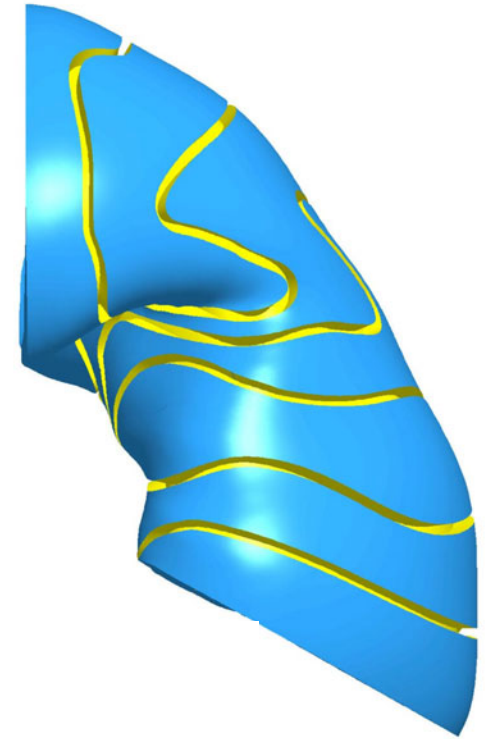

# Port-Based Maintenance Approach

- ITER-like rail system + articulated boom extremely challenging in CS geometry due to “roller coaster effect” and to non-uniform plasma shape and space
- Preferable to design maintenance based on articulated boom only
  - required reach a function of machine size and number of ports
- Maintenance through limited number of ports
  - Compatible with 2 or 3 field-period
  - More demanding limit on module weight
- Maintenance through ports between each pair of adjacent coil
  - Seems only possible with 2-field period for reasonable-size reactor (space availability)
  - “heavier” blanket module possible

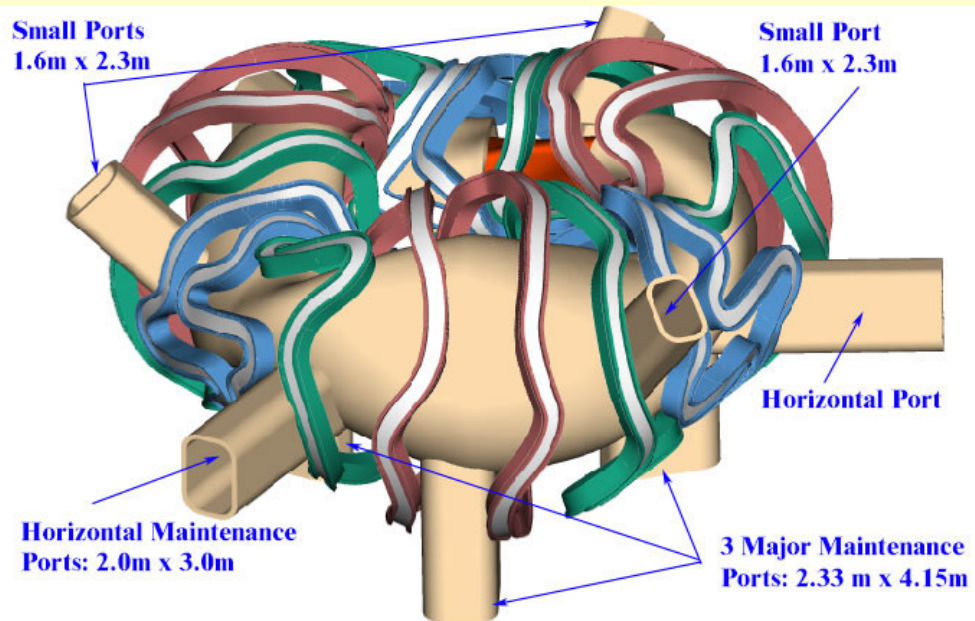

# Comparison of Horizontal Port Access Area Between Adjacent Coils for Different Configurations

Horizontal space available between coils, toroidal dimension x poloidal dimension (m x m)  
 Cyan blue indicate space availability for an example minimum 2 m x 3 m port dimensions

Port	Port #1	Port #2	Port #3	Port #4	Port #5	Port #6	Port #7	Port #8
<b>Configuration</b>								
NCSX-like 3-field period with 18 coils R=8.25 m	2.3 x 11.0	1.5 x 10.2	1.2 x 5.0	2.0 x 3.0	3.5 x 3.6	2.2x10.5		
R=9.68 m	2.8 x 12.8	1.8 x 11.9	1.4 x 5.9	2.4 x 3.6	4.1 x 4.2	2.6x12.3		
R=6.1 m	1.8x8.3	1.1x7.7	0.9x3.8	1.5x2.3	2.6x2.7	1.7x7.9		
2-field period with 16 coils R=7.5 m*	3.7 x 9.4	3.8 x 8.3	4.0 x 5.1	3.6 x 4.3	4.4 x 4.7	3.7 x 7.4	3.7 x 9.4	4.4 x 10.2
R=6.62 m	3.2 x 8.2	3.4 x 7.4	3.5 x 4.5	2.5 x 3.8	3.9 x 4.1	3.3 x 6.5	3.3 x 8.3	3.9 x 9.0
R=6.34 m	3.0 x 7.9	3.2 x 7.0	3.4 x 4.2	2.4 x 3.6	3.7 x 3.9	3.1 x 6.2	3.1 x 7.9	3.7 x 8.6

\* Assuming a coil cross-section of 0.57 m x 1.15 m



# Port-Maintenance Scheme Includes a Vacuum Vessel Internal to the Coils

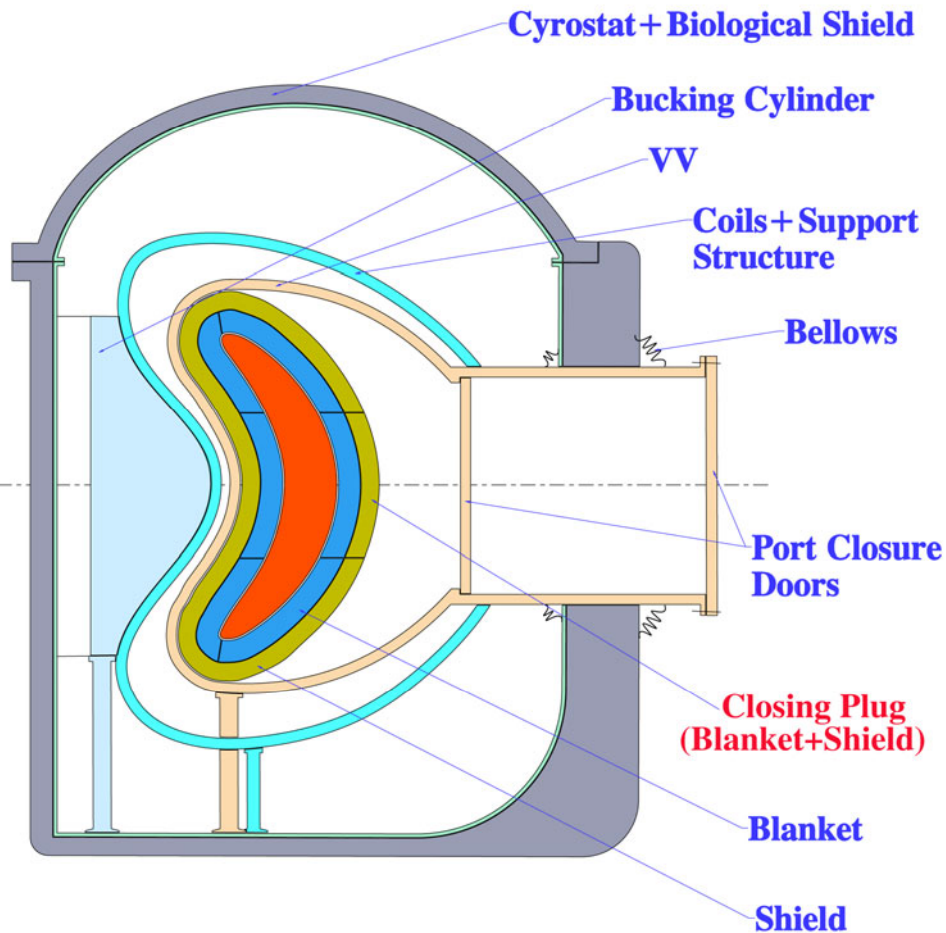

- Internal VV serves as an additional shield for the protection of the coils from neutron and gamma irradiation.
- No disassembling and re-welding of VV required for blanket maintenance.
- Closing plug used in access port
- Utilize articulated boom to remove and replace blanket modules

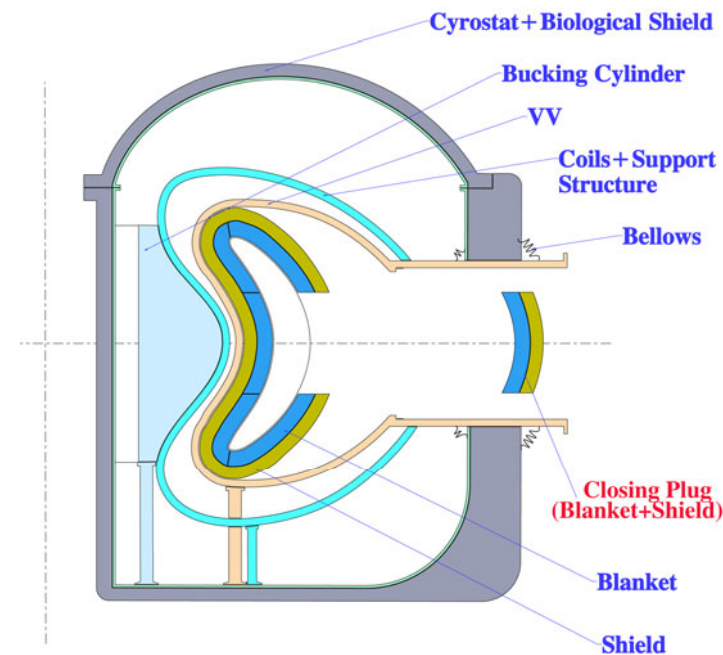

**Cross section of 3 field-period configuration at 0° illustrating the layout for port-based maintenance.**

# Scoping Study of Blanket Concepts\*

**\*Detailed radial build and neutronics study presented in :**

**L. El-Guebaly, R. Raffray, S. Malang, J. Lyon, L.P. Ku and the ARIES Team, "Benefits of Radial Build Minimization and Requirements Imposed on ARIES-CS Stellarator Design," 16<sup>th</sup> TOFE, O-II-1.5**

**Also: L. El-Guebaly, P. Wilson, D. Paige and the ARIES Team, "Initial Activation Assessment for ARIES-CS Stellarator Power Plant, " 16<sup>th</sup> TOFE, P-II-29**



# Example Blanket Modular Design Approach: SiC<sub>f</sub>/SiC as Structural Material and Pb-17Li as Breeder/Coolant

Based on ARIES-AT concept

- High pay-off, higher development risk concept
  - SiC<sub>f</sub>/SiC: high temperature operation and low activation
  - Key material issues: fabrication, thermal conductivity and maximum temperature limit (including Pb-17Li compatibility)
- Replaceable first blanket region
- Lifetime shield (and second blanket region in outboard)
- Mechanical module attachment with bolts
  - Shear keys to take shear loads (except for top modules)
- Example replaceable blanket module size ~2 m x 2 m x 0.25m (~ 500-600 kg when empty) consisting of a number of submodules (here 10)
- Thickness of breeding region for acceptable tritium breeding (~1.1 net) ~0.5 m

Cross Section of ARIES-CS Outboard Blanket/Shield  
(One Segment)

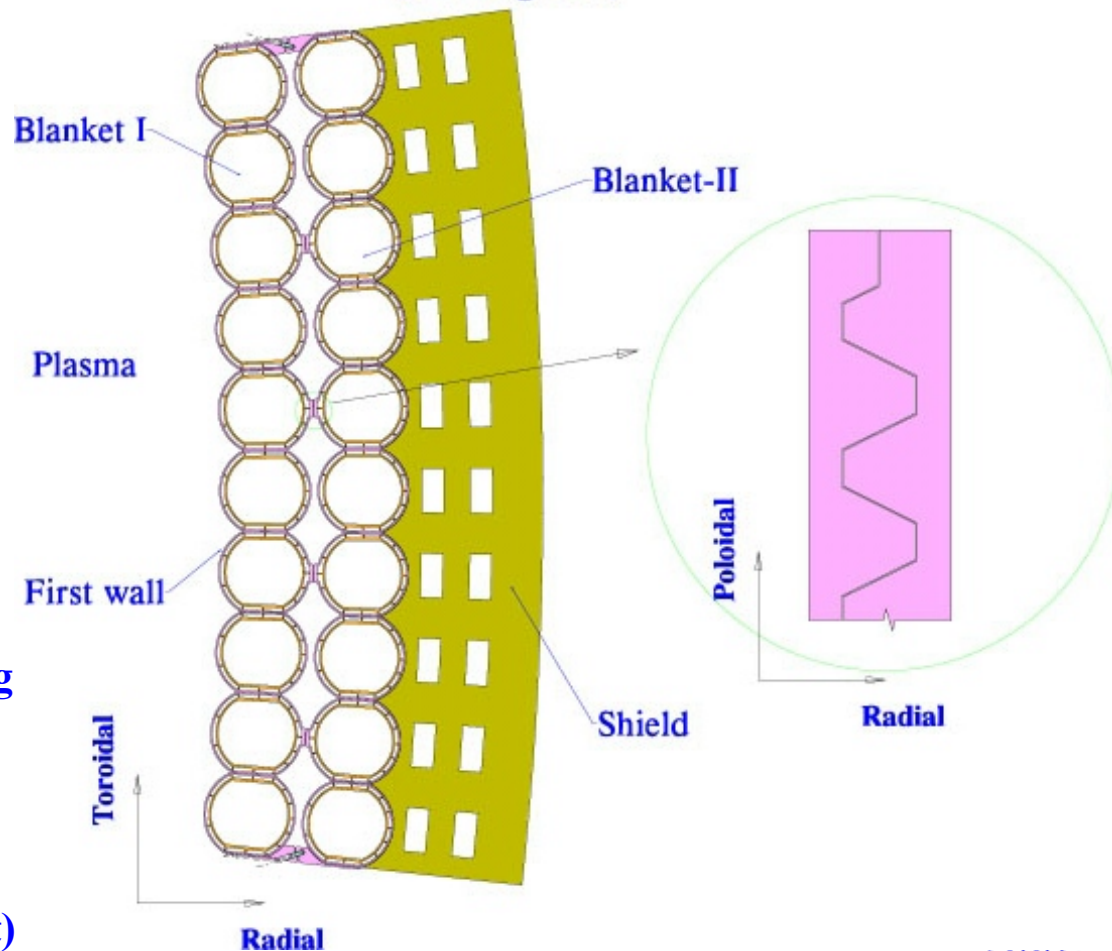

# Coolant Flow and Connection for ARIES-CS Blanket Modular Design Using SiC<sub>f</sub>/SiC and Pb-17Li

- **Two-pass flow through submodule**
  - First pass through annular channel to cool the box
  - Slow second pass through large inner channel
- **Helps to decouple maximum SiC<sub>f</sub>/SiC temperature from maximum Pb-17Li temperature**
  - Maximize Pb-17Li outlet temperature (and Brayton cycle efficiency)
  - Maintain SiC<sub>f</sub>/SiC temperature within limits
- **Possible use of freezing joint behind shield for annular coolant pipe connection**
  - Inlet in annular channel, high temp. outlet in inner channel

Cross-section Showing Coolant Flow Path and Access Tube

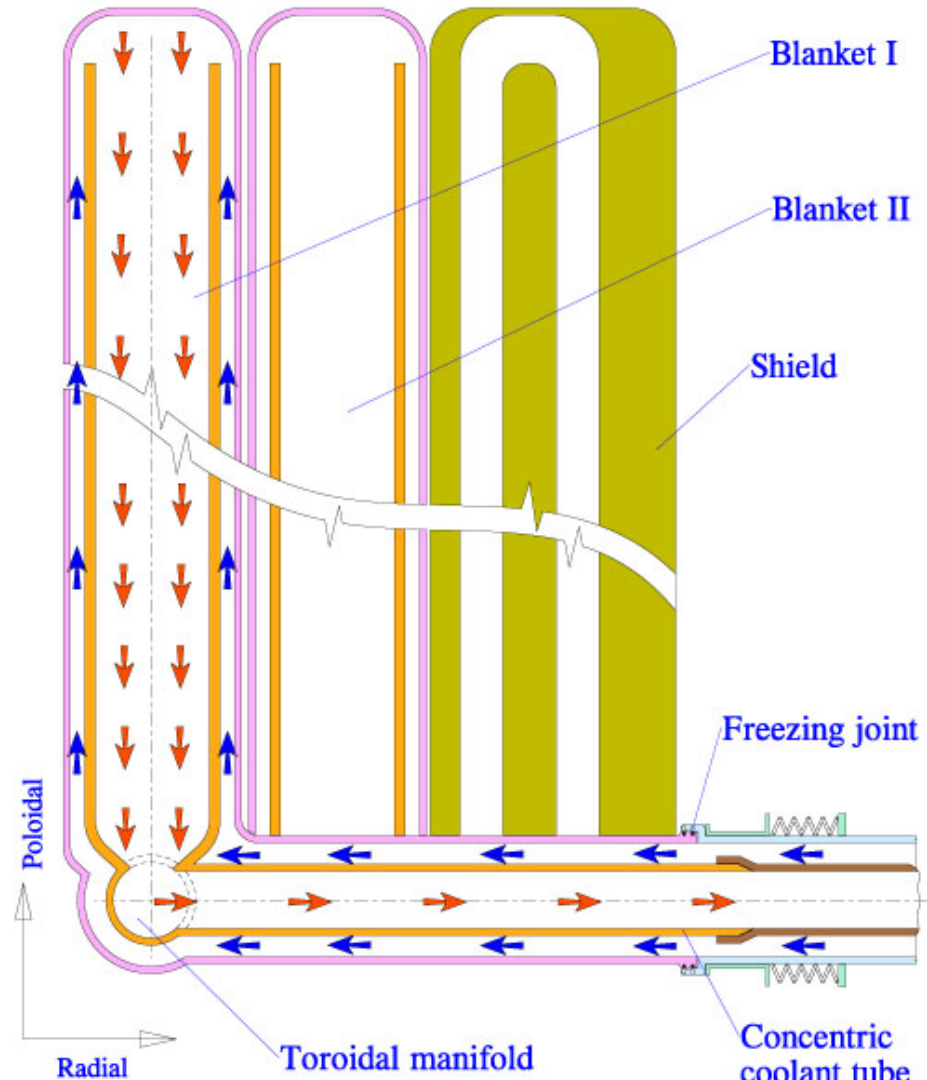

# Temperature Distribution in Example ARIES-CS Blanket Modular Design Using SiC<sub>f</sub>/SiC and Pb-17Li

- Pb-17Li Inlet Temperature ~ 699°C
- Pb-17Li Outlet Temperature ~ 1100°C
- Maximum SiC/SiC Temperature ~ 970 °C
- Maximum SiC/LiPb Temperature ~ 900 °C
- Brayton cycle efficiency ~58%

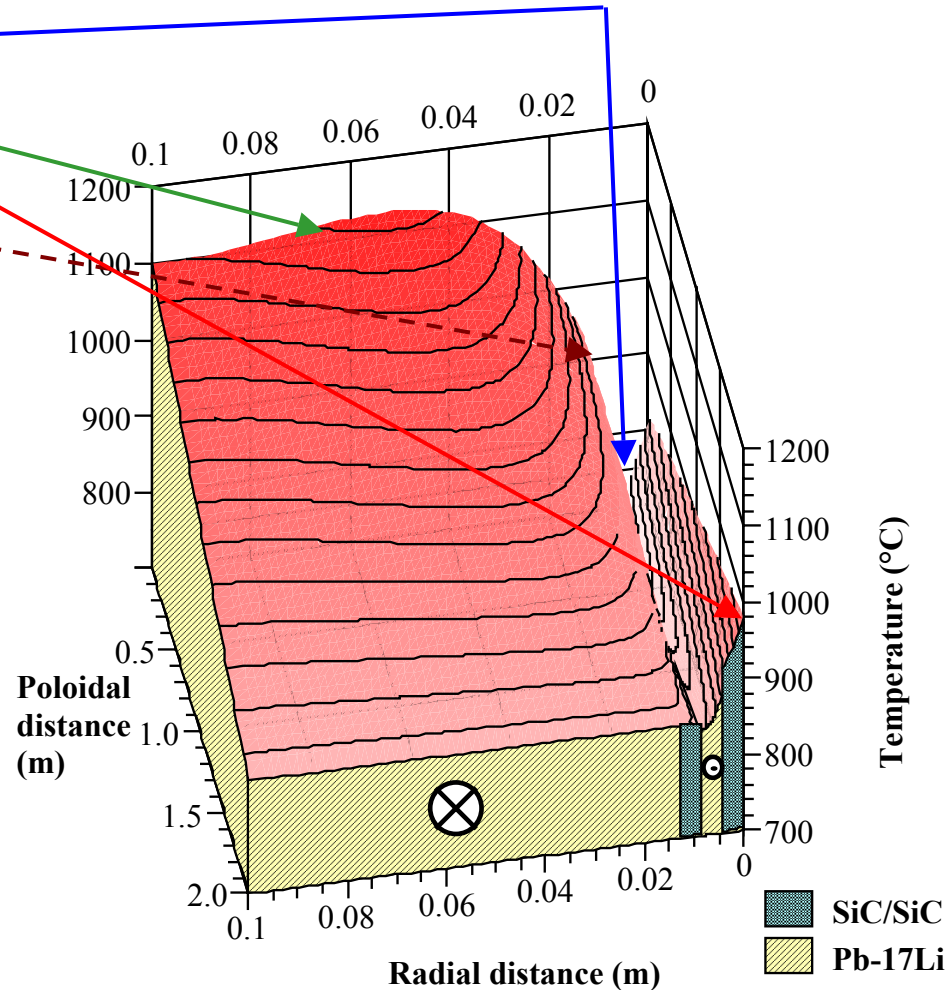
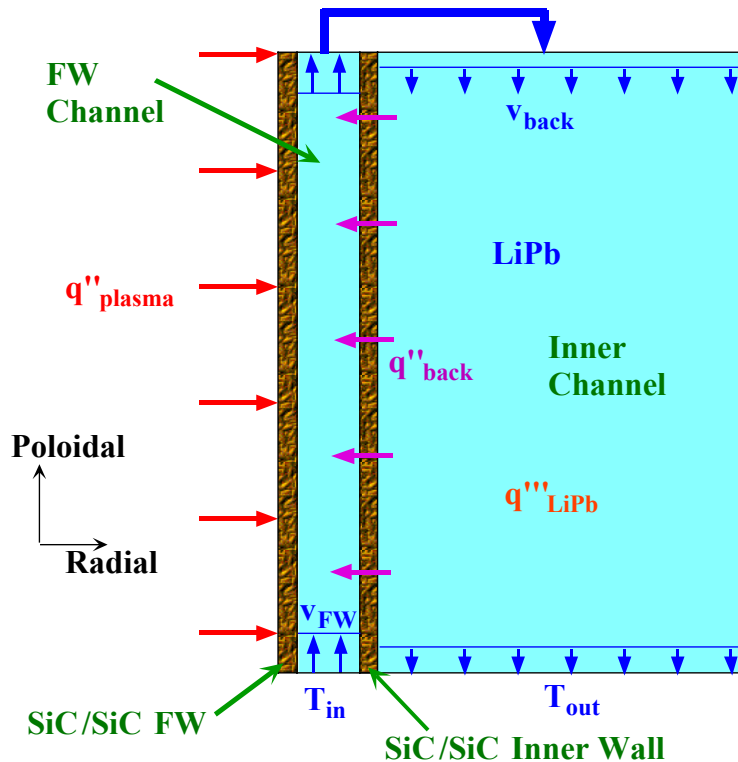



# Schematic of Dual Coolant He/LM + FS Blanket Concept

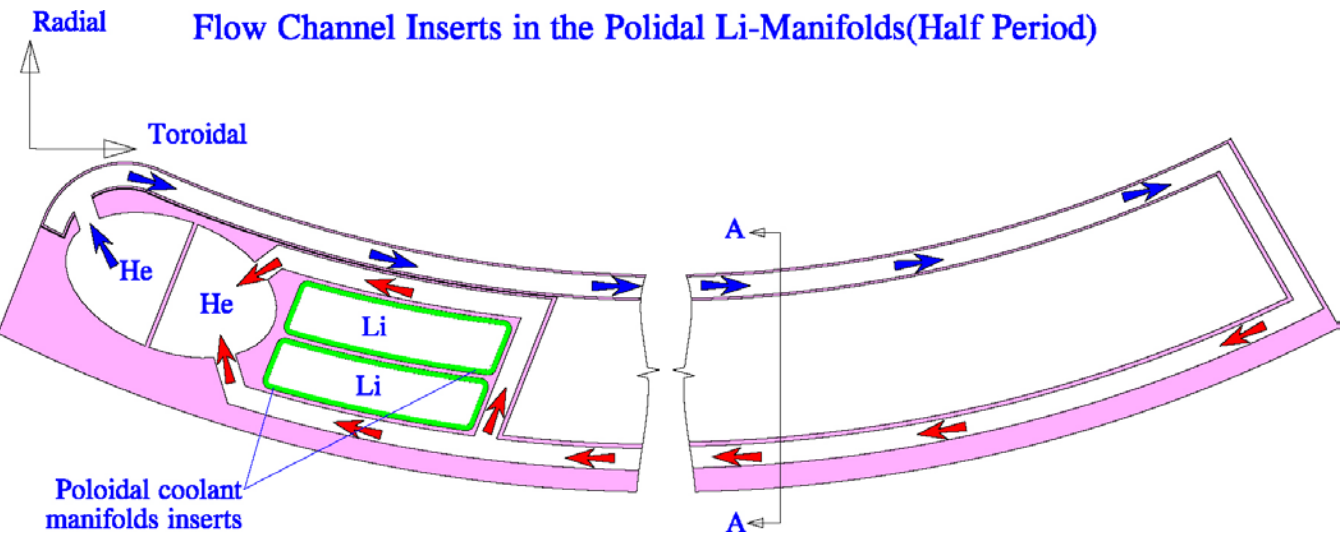

## Cross section of toroidal cooling channels

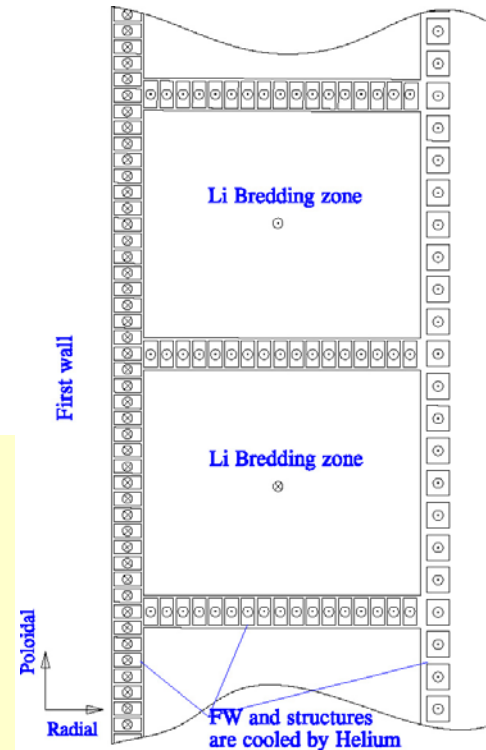

- Li and Pb-17Li as possible LM
  - He-cooled FW (no need for FW insulator)
  - Example shown assumes Li and field-period based maintenance (also applicable to port-based maintenance)
  - Possibility of increasing operating temp. by local use of ODS FS
  - Volumetric heating of the breeder/coolant provides the possibility to set the coolant outlet temperatures beyond the maximum structural temperature limits.
- FW and the entire steel structure cooled with helium.
  - Li flowing slowly toroidally (parallel to major component of magnetic field) to minimize MHD pressure drop used as breeder/coolant in the breeding zone.
  - electrically insulating coating between Li and FS not required but thermal insulating layer might be needed to maintain Li/FS temp. within its limit ( $<\sim 600^{\circ}\text{C}$ )

# Example Li/He DC Blanket Parameters for 2 GW Fusion Power Plant

- **For one replacement unit (1/6 of entire machine):**
  - Total thermal power to be removed **400 MW**
  - Heat to be removed with Li/He **~300/100 MW**
- **Helium cooling of FW**
  - Pressure **8MPa**
  - Inlet/outlet temperature **400/500°C**
  - Velocity **70 m/s**
  - Heat transfer coefficient **4,200 W/(m<sup>2</sup>-K)**
  - Pressure drop **0.1 MPa**
- **Lithium cooling of breeding zone**
  - Inlet/outlet temperature **500/800°C**
  - Velocity **0.12 m/s**
  - Heat transfer coefficient **450 W/(m<sup>2</sup>-K)**
  - Pressure drop (*assuming perpendicular B=1T*) **0.1 MPa**
- **Blanket coupled to Brayton cycle through HX (efficiency > 45%)**
- **Tritium self-sufficiency has been estimated with breeding zones ~ 47-62 cm**



# Considerations on Choice of Module Design and Power Cycle for a Ceramic Breeder Concept

- The blanket module design pressure impacts the amount of structure required, and, thus, the module weight & size, the design complexity and the TBR.
- For a He-cooled CB blanket, the high-pressure He will be routed through tubes in the module designed to accommodate the coolant pressure. The module itself under normal operation will only need to accommodate the low purge gas pressure (~ 1-10 bar).
- The key question is whether there are accident scenarios that would require the module to accommodate higher loads.
- If coupled to a Rankine Cycle, the answer is yes (EU study)
  - Failure of blanket cooling tube + subsequent failure of steam generator tube can lead to Be/steam interaction and safety-impacting consequences.
  - Not clear whether it is a design basis ( $<10^{-6}$ ) or beyond design basis accident (passive means ok).
- To avoid this and still provide possibility of simpler module and better breeding, we investigated the possibility of coupling the blanket to a Brayton Cycle.

# Ceramic Breeder Blanket Module Configuration

- Simple modular box design with coolant flowing through the FW and then through the blanket
  - 4 m (poloidally) x 1 m (toroidally) module
  - Be and CB packed bed regions aligned parallel to FW
  - $\text{Li}_4\text{SiO}_4$  or  $\text{Li}_2\text{TiO}_3$  as possible CB
  - He flows through the FW cooling tubes in alternating direction and then through 3-passes in the blanket

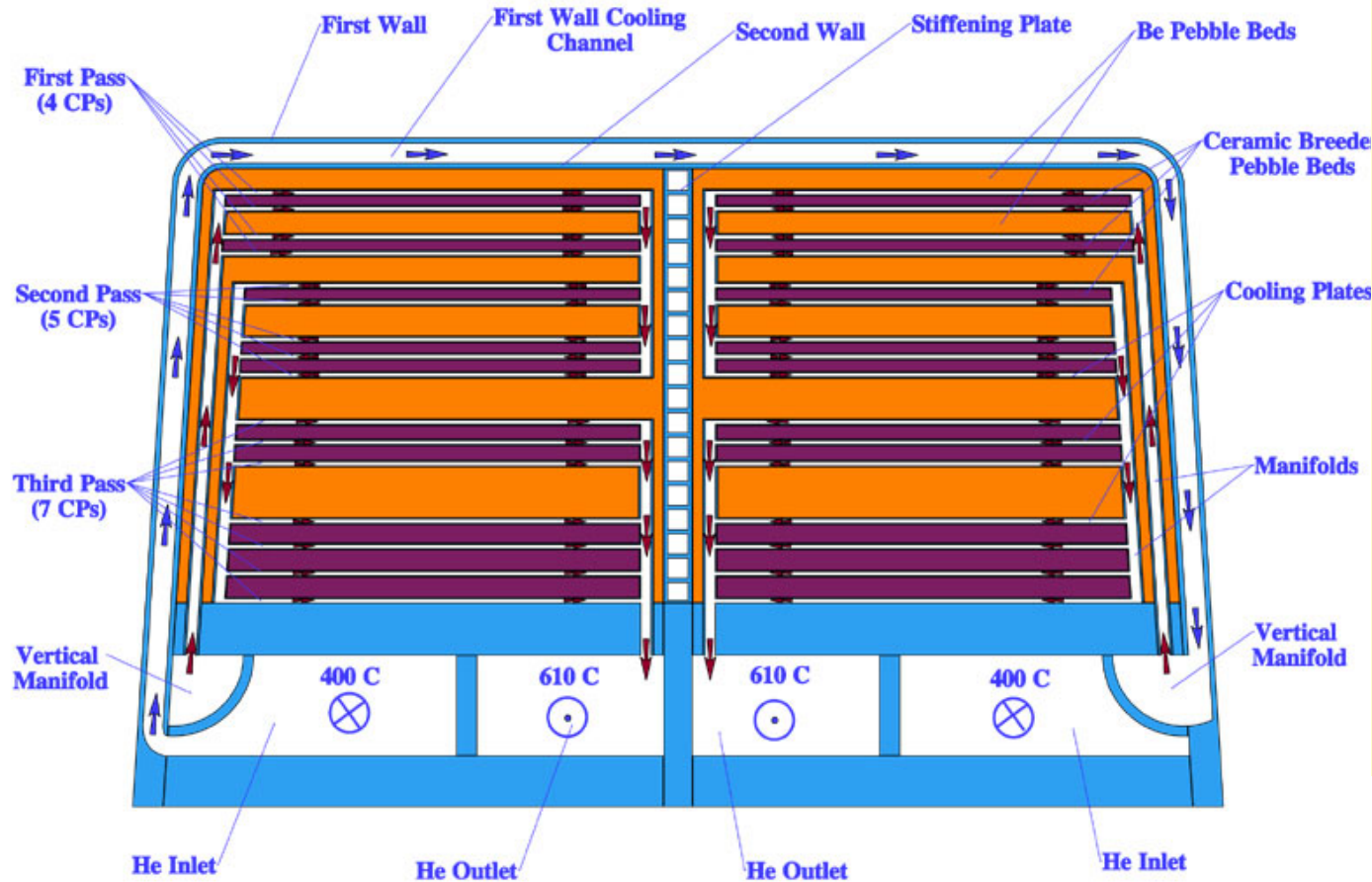

- Initial number and thicknesses of Be and CB regions optimized for  $\text{TBR}=1.1$  based on:
  - $T_{\text{max,Be}} < 750^\circ\text{C}$
  - $T_{\text{max,CB}} < 950^\circ\text{C}$
  - $k_{\text{Be}}=8 \text{ W/m-K}$
  - $k_{\text{CB}}=1.2 \text{ W/m-K}$
  - $\delta_{\text{CB region}} > 0.8 \text{ cm}$
- 6 Be regions + 10 CB regions for a total module radial thickness of 0.65 m



# Example Scoping Study of CB Blanket with a Brayton Cycle

**Brayton cycle with 3-stage compression + 2 inter-coolers and a single stage expansion**

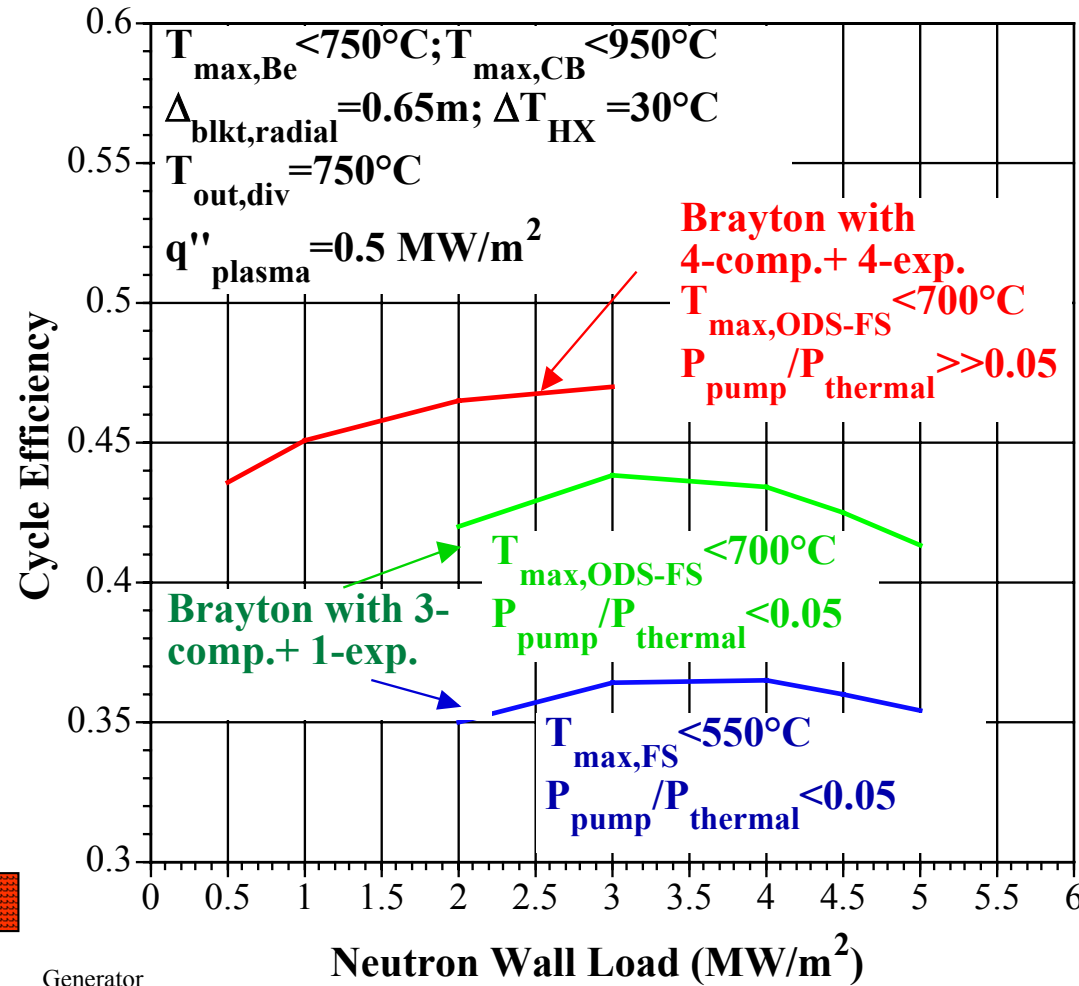
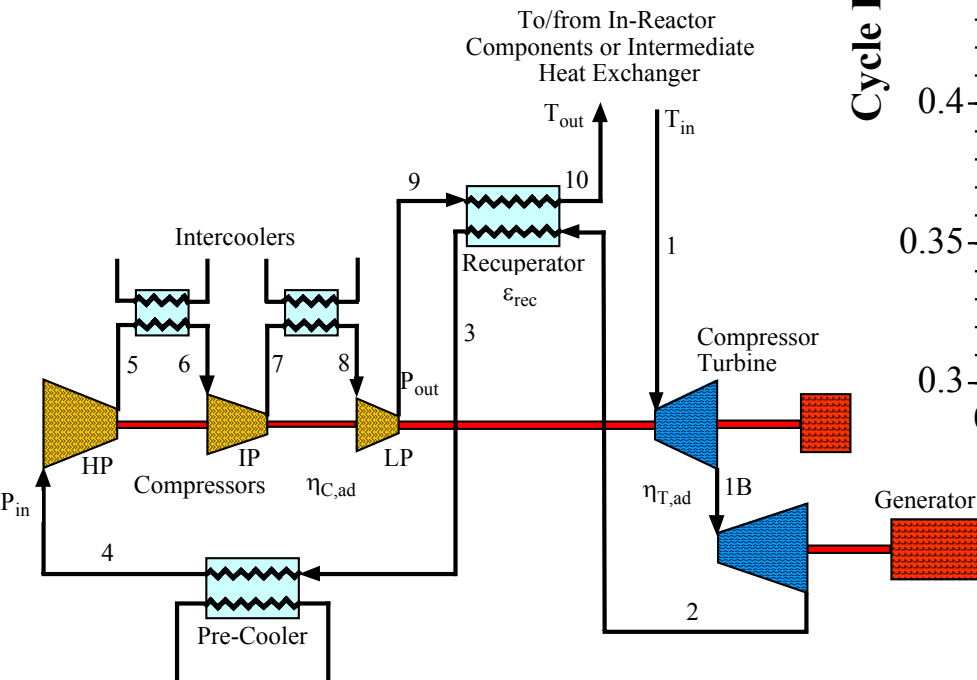

**More details from 16th TOFE presentation: A. R. Raffray, S. Malang, L. El-Guebaly, X. Wang and the ARIES Team, "Ceramic Breeder Blanket for ARIES-CS," O-II-5.6**

# Example Flibe + FS Blanket Concept

- Self-cooled configuration where the flibe first cools the entire structure and then flows slowly in the large central ducts.
- With a flibe exit temperature of  $700^{\circ}\text{C}$ , it is believed that a cycle efficiency of  $>45\%$  is achievable when coupling a Brayton cycle to the blanket via a HX.
- Such a self-cooled flibe MP= $459^{\circ}\text{C}$ ) blanket can only be utilized in connection with ODS FS (with nano-size oxide particles,  $T_{\text{max}} \sim 800^{\circ}\text{C}$ ) and requires Be pebble beds as neutron multiplier and for chemistry control.
- A dual-coolant version of the concept with He cooling the steel structure would allow for a more “conventional” reduced activation FS ( $T_{\text{max}} \sim 550^{\circ}\text{C}$ ), the use of lower melting point molten salts, and the possible replacement of Be multiplier by liquid lead.

Cross-section of the Flibe Blanket Box (Front View)

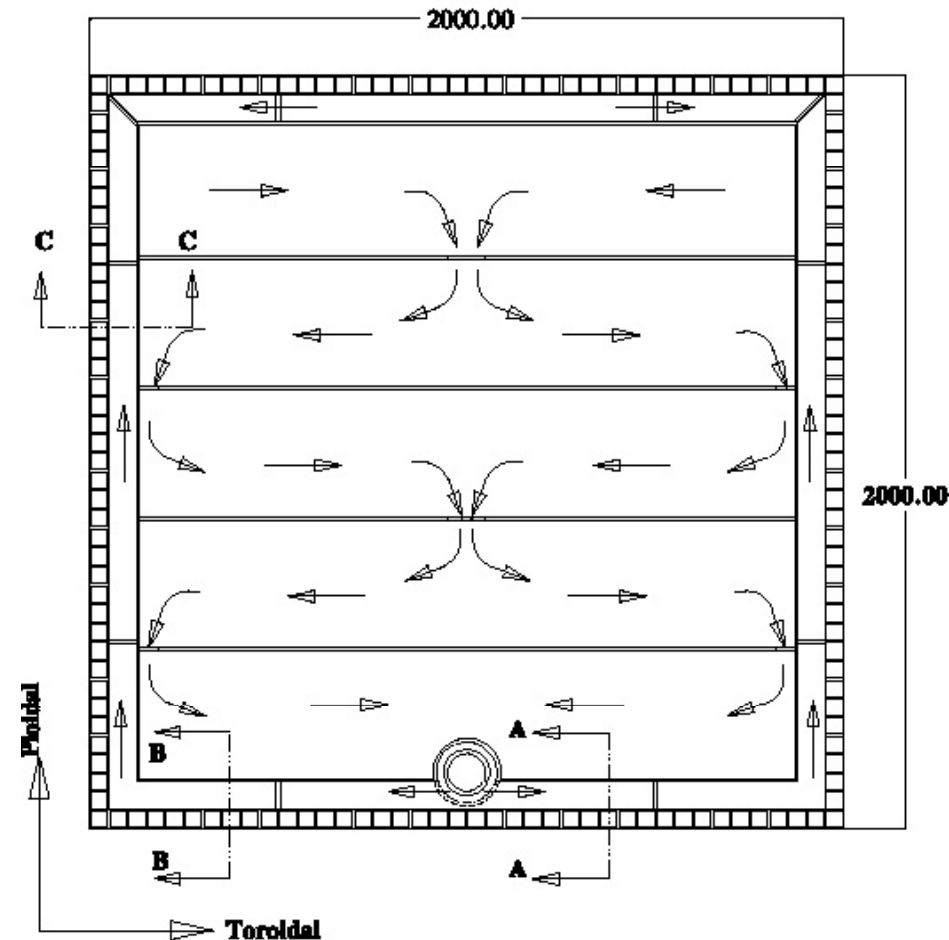

# Major Parameters of Different Blanket Concepts

Blanket Concepts Considered During Phase I of ARIES-CS	Self-Cooled Molten Salt	Self-Cooled Pb-17Li	Li Dual-Coolant Concept	Pb-17Li Dual-Coolant Concept	Ceramic Breeder
Breeder (form)	Flibe	Pb-17Li	Li	Pb-17Li	Li <sub>4</sub> SiO <sub>4</sub> (pebble bed)
Multiplier (form)	Be(pebble bed)	None	None	None	Be(pebble bed)
Coolant	Flibe	Pb-17Li	He + self	He + self	He
Structure	ODS FS (nano-sized)	SiC <sub>f</sub> /SiC	RAFS & ODS FS (+SiC insert if required)	RAFS & ODS FS	RAFS & ODS FS
Struct. T <sub>max</sub> (°C)	700	1000	550 (RAFS) 700 (ODS FS)	550	550 (RAFS) 700 (ODS FS)
Breeder T <sub>max</sub> (°C)	700	1100	800	700	950
Breeder T <sub>min</sub> (°C)	550	650	500	460	
Multiplier T <sub>max</sub> (°C)	750				750
Multiplier T <sub>min</sub> (°C)					
Coolant T <sub>out</sub> (°C)			He : 500	He : 480	610
Coolant T <sub>in</sub> (°C)			He: 400	He : 300	400
Coolant P (MPa)	<0.5 (FLIBE)	2 (Pb-17Li)	He : 8	He : 14	8
Blanket thickness (m)	0.33	0.5	0.67-0.75	0.52-0.6	0.65
Avg./peak neutron wall load for analysis (MW/m <sup>2</sup> )	2/3	2/3	2/3	2/3	3/4.5
Upper limit on neutron wall Load (MW/m <sup>2</sup> )	3	4-5 (TBD)	4-5 (TBD)	4-5 (TBD)	~5
Surf. Heat Flux (MW/m <sup>2</sup> )	0.5	0.5	0.5	0.5	0.5
TBR	□1.1	□1.1	□1.1	□1.1	□1.1
Cycle η (%)	~45	~58%	>45	~45	~42
Structural material lifetime and criteria	20 MW-a/m <sup>2</sup> 200 dpa swelling?	18 MW-a/m <sup>2</sup> assuming 3% SiC burnup?	21 MW-a/m <sup>2</sup> 200 dpa swelling?	15 MW-a/m <sup>2</sup> 200 dpa swelling?	20 MW-a/m <sup>2</sup> 200 dpa swelling?

# Summary of Engineering Effort During Phase-I of ARIES-CS: Maintenance Schemes

- **Good understanding of a range of possible maintenance schemes and blanket concepts when applied to a compact stellarator.**
- **Ready to downselect for Phase II.**
- **In the area of CS maintenance, it seems healthy to maintain two options:**
  - **Field period replacement**
  - **Replacement of relatively small modules through a small number of ports (perhaps 1 or 2 per field period) with the use of articulated booms.**
  - **More details of the procedures involved needed in both cases**
  - **Final selection of maintenance scheme will have to be compatible with the machine configuration based on our physics and system optimization during Phase II**





# Summary of Engineering Effort During Phase-I of ARIES-CS: Some General Observations on Down-Selection of Blanket Concepts

- **Ceramic Breeder Concepts**
  - Requires large heat transfer surfaces (impact on complexity, fabrication, cost)
  - Relatively thick breeding zone
  - Modest cycle efficiency
- **Molten salts**
  - In general, poor heat transfer performance
  - Limits  $q''$  and wall load that could be accommodated for self-cooled concept
  - Self-cooled flibe blanket only feasible with advanced ODS FS.
  - DC concept with He as FW coolant preferable
- **DC Concepts (He/Liquid Breeder)**
  - He cooling needed most probably for ARIES-CS divertor (to be fully studied as part of Phase II).
  - Additional use of this coolant for the FW/structure of blankets facilitates pre-heating of blankets, serves as guard heating, and provides independent and redundant afterheat removal
  - Generally good combination of design simplicity and performance
- **Reasonable to maintain a higher pay-off, higher risk option in Phase II mix (e.g. high temperature option with SiC<sub>f</sub>/SiC)**
- **ARIES-CS meeting tomorrow for final decision**



# Results of ARIES-CS Phase I Effort Presented at 16<sup>th</sup> TOFE

## Invited Oral Papers for ARIES Special Session

1. F. Najmabadi and the ARIES Team, "Overview of ARIES-CS Compact Stellarator Study"
2. P. Garabedian, L. P. Ku, and the ARIES Team, "Reactors with Stellarator Stability and Tokamak Transport"
3. J.F. Lyon, L. P. Ku, P. Garabedian and the ARIES Team, "Optimization of Stellarator Reactor Parameters"
4. A. R. Raffray, L. El-Guebaly, S. Malang, X. Wang and the ARIES Team, "Attractive Design Approaches for Compact Stellarator"
5. L. El-Guebaly, R. Raffray, S. Malang, J. Lyon, L.P. Ku and the ARIES Team, "Benefits of Radial Build Minimization and Requirements Imposed on ARIES-CS Stellarator Design"

## Contributed Papers

6. L. El-Guebaly, P. Wilson, D. Paige and the ARIES Team, "Initial Activation Assessment for ARIES-CS Stellarator Power Plant"
7. L. El-Guebaly, P. Wilson, D. Paige and the ARIES Team "Views on Clearance Issues Facing Radwaste Management of Fusion Power Plants"
8. S. Abdel-Khalik, S. Shin, M. Yoda, and the ARIES Team, "Design Constraints for Liquid-Protected Divertors"
9. X. Wang, S. Malang, A. R. Raffray and the ARIES Team, "Maintenance Approaches for ARIES-CS Power"
10. A. R. Raffray, S. Malang, L. El-Guebaly, X. Wang and the ARIES Team, "Ceramic Breeder Blanket for ARIES-CS"

