

Nuclear Assessment of Final Optics of a KrF Laser Driven Fusion Power Plant

Mohamed Sawan

Fusion Technology Institute
University of Wisconsin, Madison, WI

M.W. McGeoch (PLEX LLC), A. Ibrahim (UW), and P. Wilson (UW)

17th TOFE
Albuquerque, NM
November 13-15, 2006

Baseline HAPL final optical parameters:

2.5 MJ at 5 Hz, 40 illumination beams each 62.5kJ

2 Jcm⁻² in optical distribution ducts

Duct aspect ratio 6:1, each beam 3x18 beamlets
(area of one beam = 3x18x(0.24)² = 3.1 m²)

Focal length 39 m (GIMM) or 42 m (all-Dielectric case)

Vertical “slits” in blanket, total 0.7% of 4π
(slit size 1.32 m high x 0.22m wide for GIMM case)

24 cm x 24 cm beamlet
from de-multiplex array

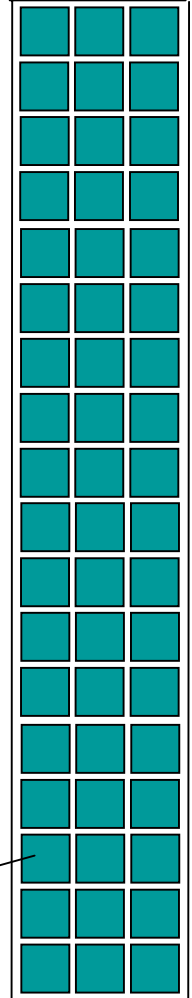

HAPL Final Optics with Grazing Incidence Metallic Mirrors

- Use of **GIMM** was first proposed by Bieri and Guinan as solution to problem of **protecting final focusing mirrors** from neutron damage

Bieri and Guinan, Fusion Technology 19, 673-678 (1991)

- **Dielectric FF mirrors** placed out of direct line-of-sight of target
- **Secondary neutrons** from interactions with GIMM and containment building can result in significant flux at final focusing mirrors
- To reduce secondary flux **neutron traps are utilized** in containment building

M. Sawan, "Three-Dimensional Neutronics Analysis for the Final Optics of the Laser Fusion Power Reactor SIRIUS-P," Proc. IEEE 16th Symposium on Fusion Engineering, Champaign, IL, Sept. 30- Oct. 5 1995, IEEE Cat. No. 95CH35852, Vol. 1, pp. 29

S. Reyes, J. Latkowski, and W. Meier, "Radiation Damage and Waste Management Options for the SOMBRERO Final Focus System and Neutron Dumps", UCRL-JC-134829, August 1999

- While **GIMMs** are expected to have better neutron damage resistance, they are more difficult to fabricate and have lower optical damage resistance than dielectric mirrors
- A HAPL final optics system utilizing GIMMs was developed and assessed



Baseline HAPL Optics Configuration with GIMM

HAPL GIMM design of 3-31-06

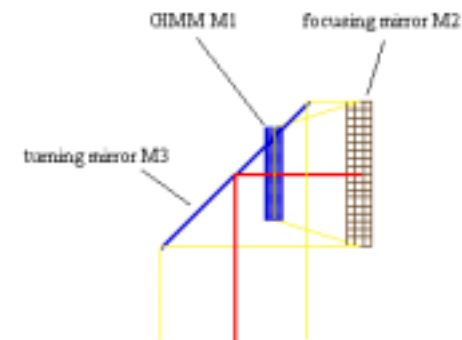
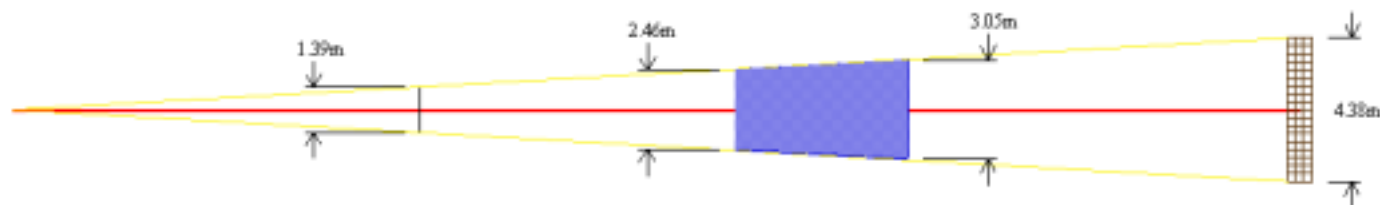
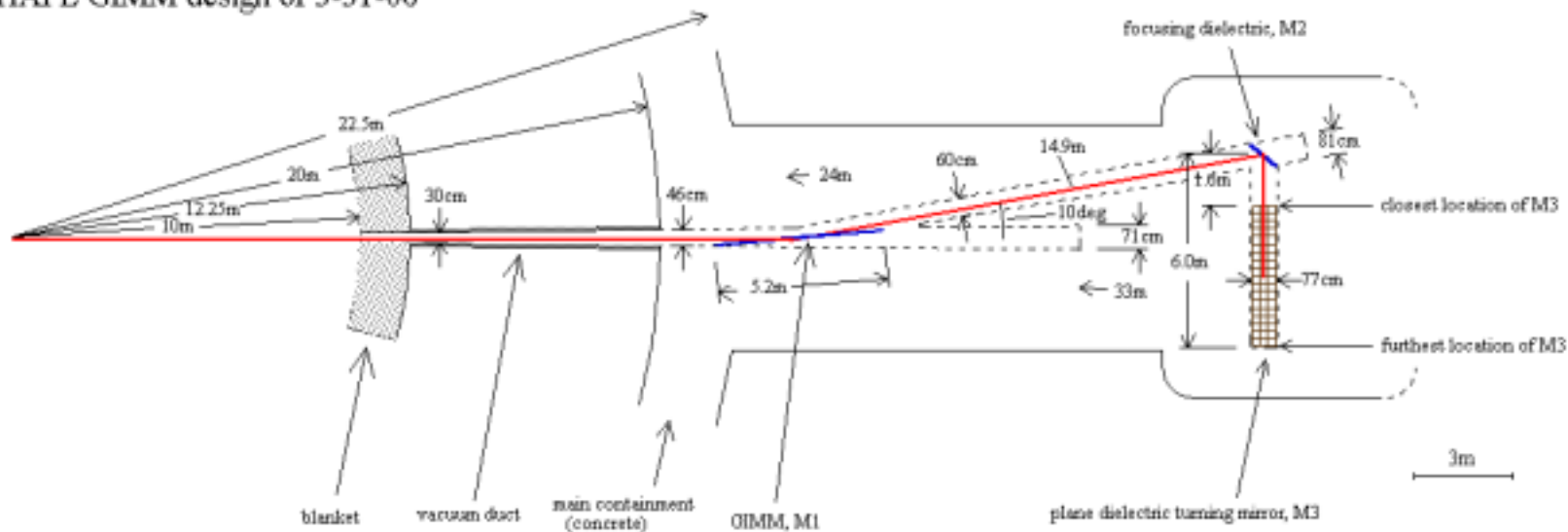

Provided by Malcolm McGeoch

Design Parameters for Baseline HAPL Design

Target yield	367.1 MJ
Rep Rate	5 Hz
Fusion power	1836 MW
Chamber inner radius	10.75 m
Thickness of Li/FS blanket	0.6 m
Thickness of SS/B ₄ C/He shield	0.5 m
Chamber outer radius	11.85 m
NWL @ FW	0.94 MW/m ²
GIMM angle of incidence	85°
GIMM distance from target	24 m



Energy Spectra of Source Neutrons and Gammas Used in Neutronics Calculations

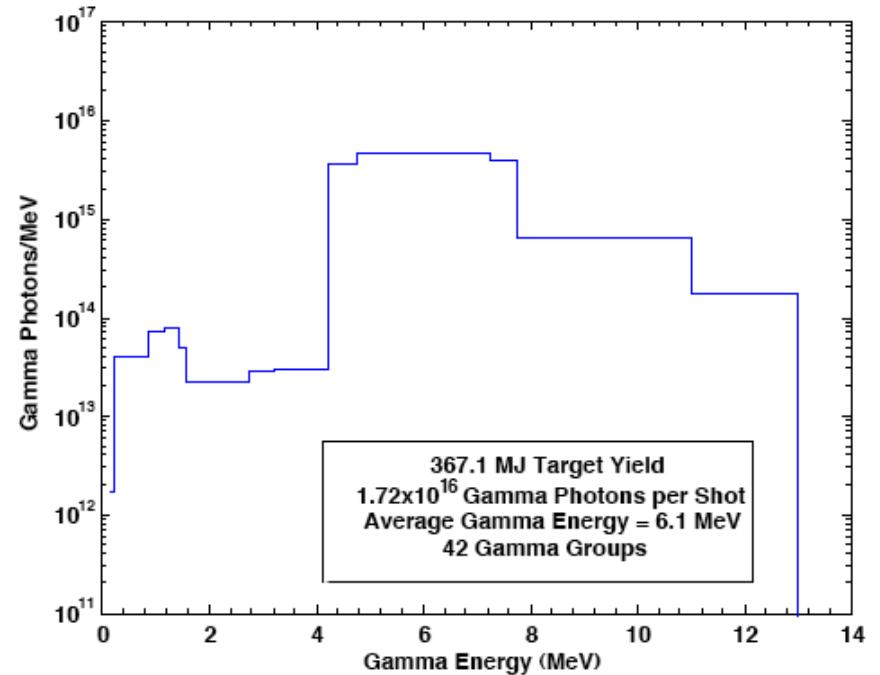
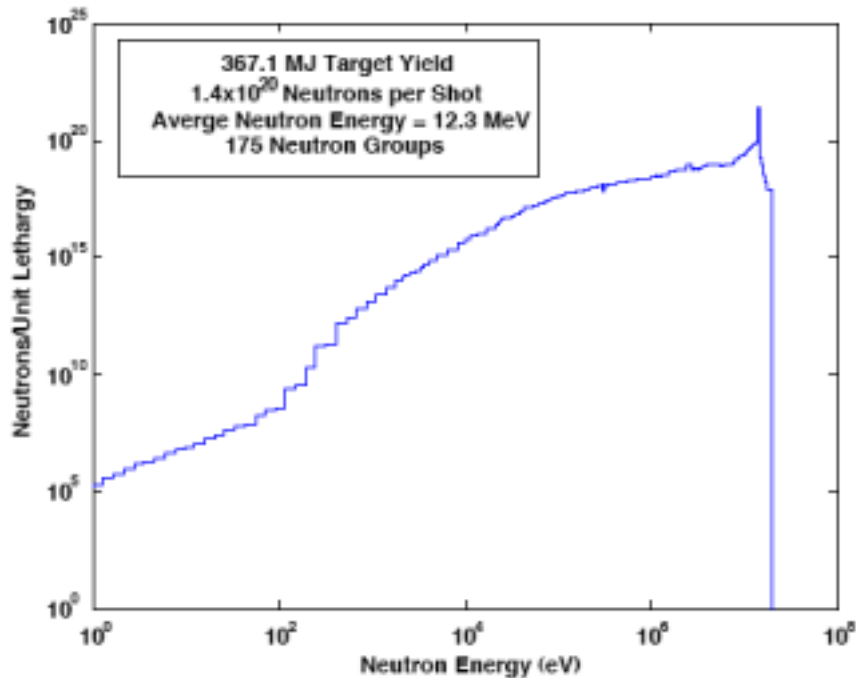

Detailed 2-D Neutronics Analysis

- 2-D calculation in R-Z geometry
- Z axis is along the beamline
- Two lightweight GIMM design options considered
- Due to 2-D modeling limitation, beam port at chamber wall modeled as circular with 0.225 m radius
- Neutron traps used behind GIMM and M2
- Effective thickness of GIMM layers as seen by source neutrons was modeled (effective thickness = actual thickness/cos85)
- Detailed layered radial build of blanket/shield included
- Containment building housing optics and neutron traps used (70% concrete, 20% carbon steel, and 10% H₂O)



Cross Section in the 2-D Neutronics Model

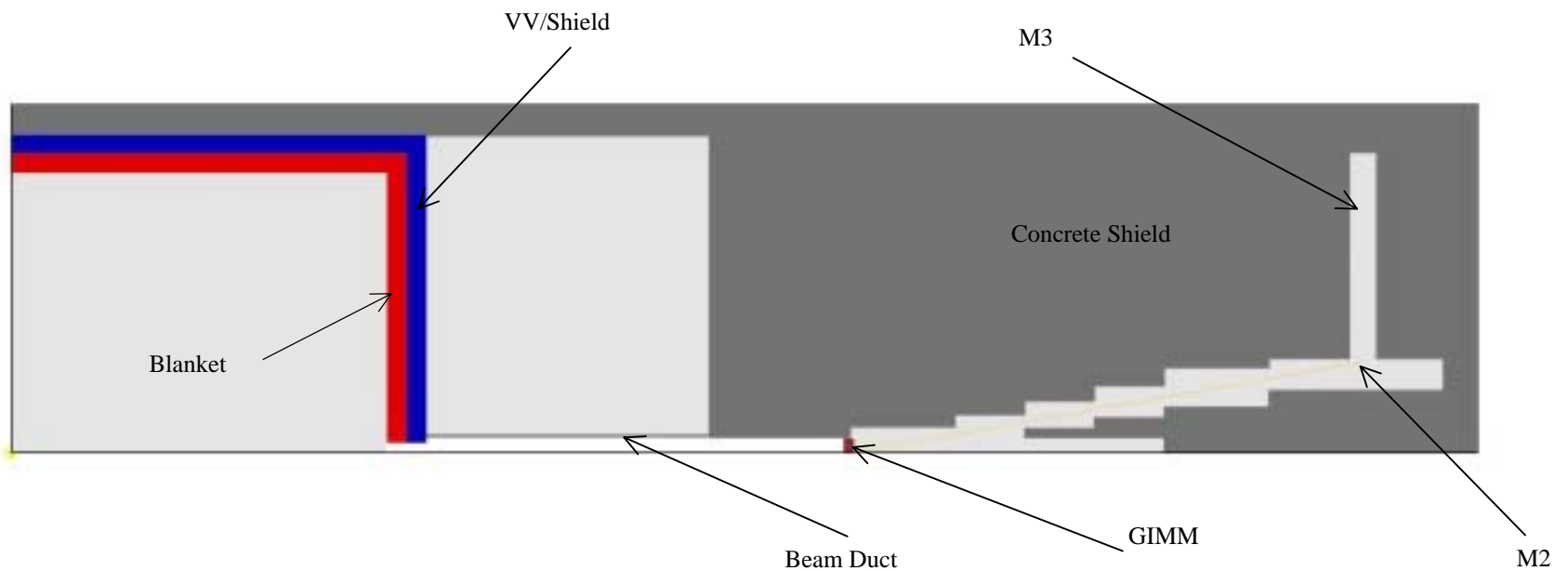

Isometric View of the 2-D Neutronics Model

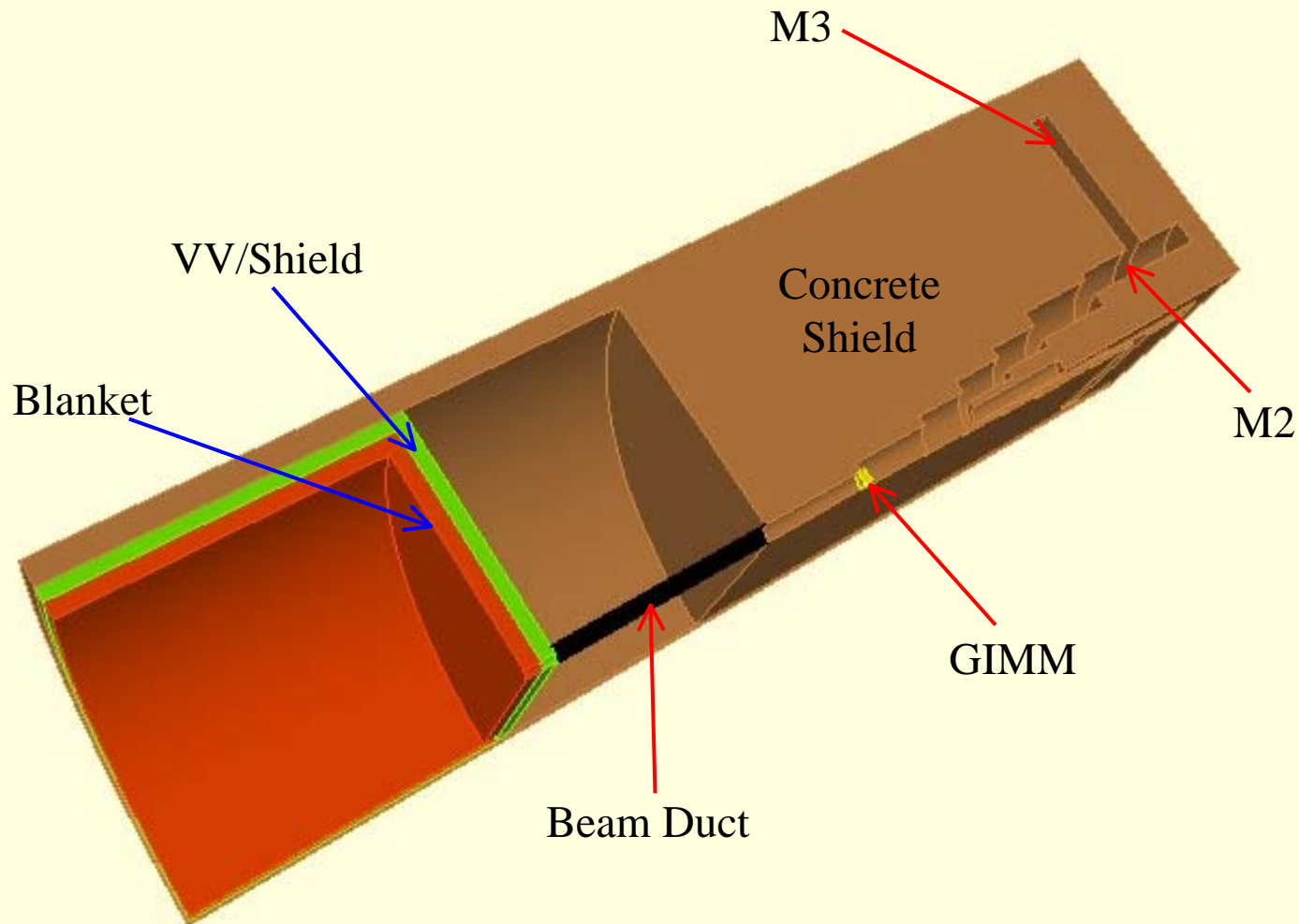

GIMM Design Options for HAPL

- Two options considered for GIMM materials and thicknesses
- Both options have 50 microns thick Al coating

Option 1: Lightweight SiC substrate

- The substrate consists of two SiC face plates surrounding a SiC foam with 12.5% density factor
- The foam is actively cooled with slow-flowing He gas
- Total thickness is 1/2"
- Total areal density is 12 kg/m²

Option 2: Lightweight AlBeMet substrate

- The substrate consists of two AlBeMet162 (62 wt.%Be) face plates surrounding a AlBeMet foam(or honeycomb) with 12.5% density factor
- The foam is actively cooled with slow-flowing He gas
- Total thickness is 1"
- Total areal density is 16 kg/m²



Impact of Liner Material Choice

- It was suggested in previous analysis that lining beam ducts with strong absorber reduces neutron streaming
- Effectiveness of lining inner surface of duct and neutron traps with strong neutron absorbers is assessed
- Liners considered are:
 - Boral ($\text{Al+B}_4\text{C}$)
 - Borated Polyethylene
 - Boron Hydride ($\text{B}_{10}\text{H}_{14}$)
 - Tungsten Carbide (WC)
- Option of adding 5% boron to the concrete shield was also investigated
- Calculations performed with SiC GIMM



Impact of Liner Material on Radiation Level at M2

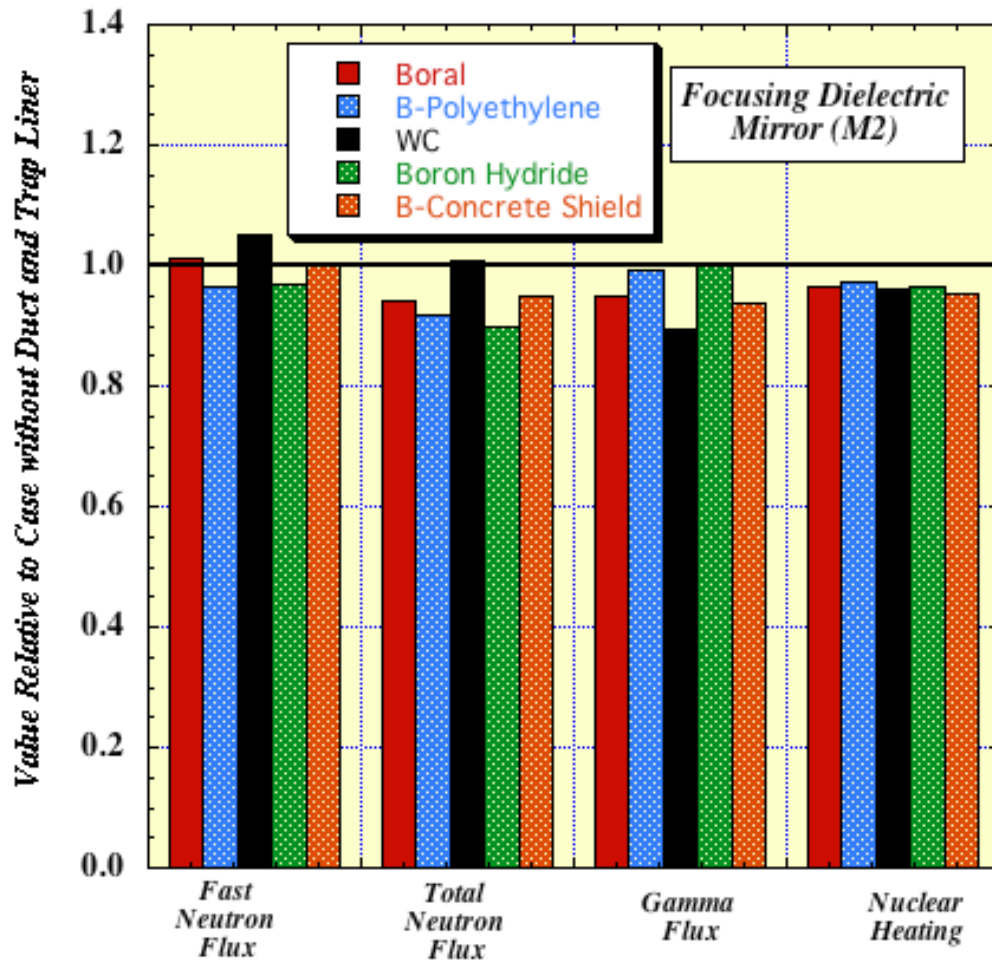

- Boron hydride and borated polyethylene have the best impact on fast neutron flux
- Heavy material (e.g., WC) effective only in reducing gamma flux
- Effect at M2 is very small since flux is dominated by neutrons scattered from GIMM
- Design complexity from adding liner is not justified

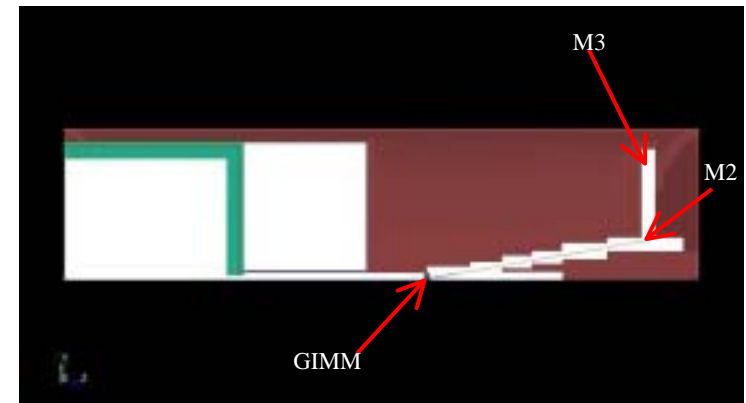

Impact of Liner Material on Radiation Level at M3

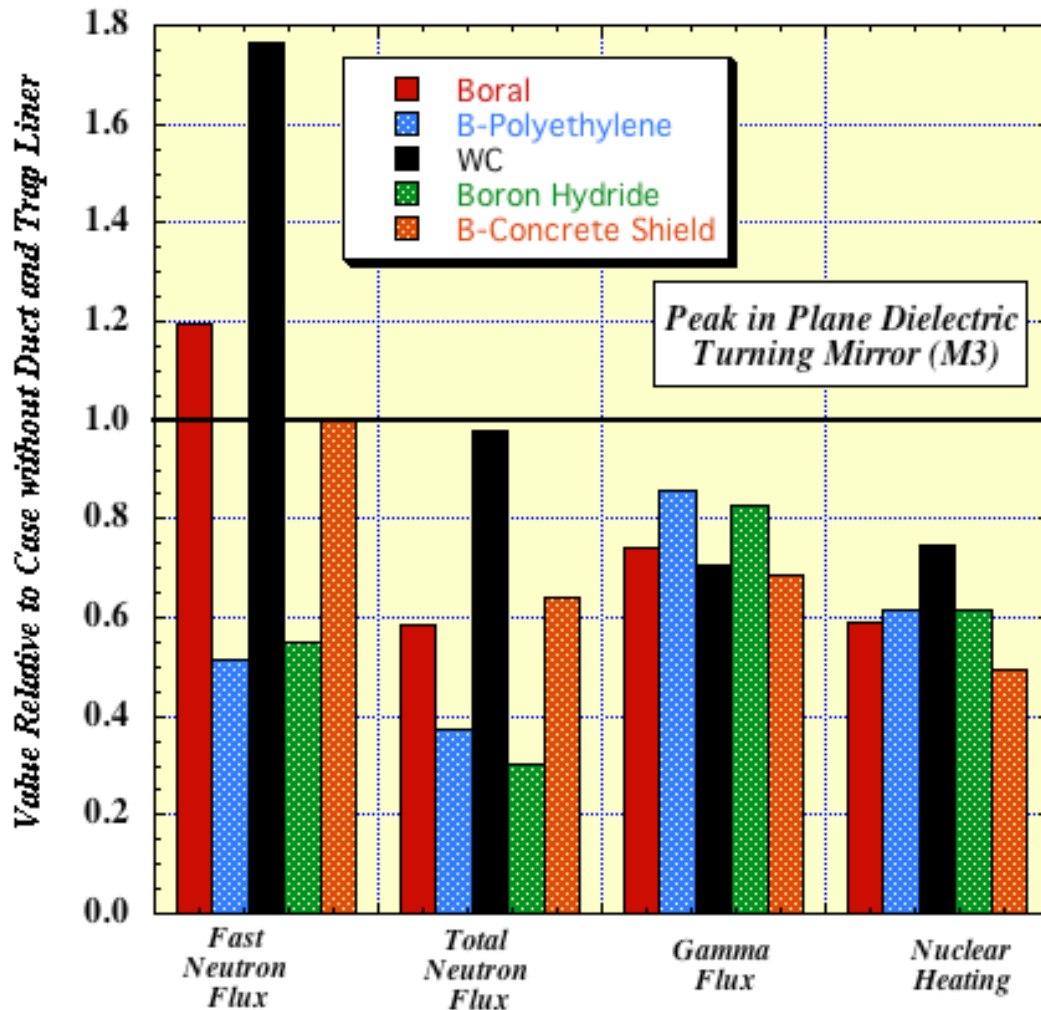

- Effect of liner enhanced at M3
- Boron hydride and borated polyethylene have the best impact on fast neutron flux
- Effect at M3 is at most a factor of 2 reduction
- Since flux at M3 is much smaller than that at M2, design complexity from adding liner is not justified

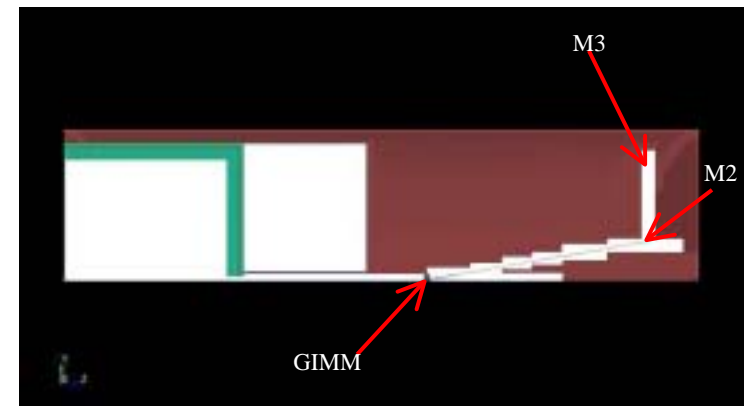

Nuclear Environment at GIMM

		Flux ($\text{cm}^{-2} \cdot \text{s}^{-1}$)
SiC GIMM (R= 23.93 m)	Neutrons E>1 MeV	1.15×10^{13}
	Neutrons E>0.1 MeV	1.27×10^{13}
	Total Neutrons	1.34×10^{13}
	Total Gamma	4.53×10^{12}
AlBeMet GIMM (R= 23.85 m)	Neutrons E>1 MeV	1.27×10^{13}
	Neutrons E>0.1 MeV	1.55×10^{13}
	Total Neutrons	1.81×10^{13}
	Total Gamma	2.58×10^{12}

- Contribution from scattering in chamber is small (<3%)
- Up to 37% of fast neutron flux contributed from scattering in GIMM itself
- n flux higher for AlBeMet (due to Be(n,2n)) and γ flux higher for SiC (due to Si inelastic scattering)
- Neutron spectrum softer for AlBeMet

- Power density in front faceplate slightly higher for SiC (0.68 compared to 0.55 W/cm³ for AlBeMet)
- For 1.2 mm thick SiC faceplate nuclear heating is 82 mW/cm² compared to 132 mW/cm² for the twice thicker AlBeMet faceplate
- This is compared to heat flux from laser (22 mW/cm²) and x-rays (23 mW/cm²)



Fast neutron Flux Along Beamline

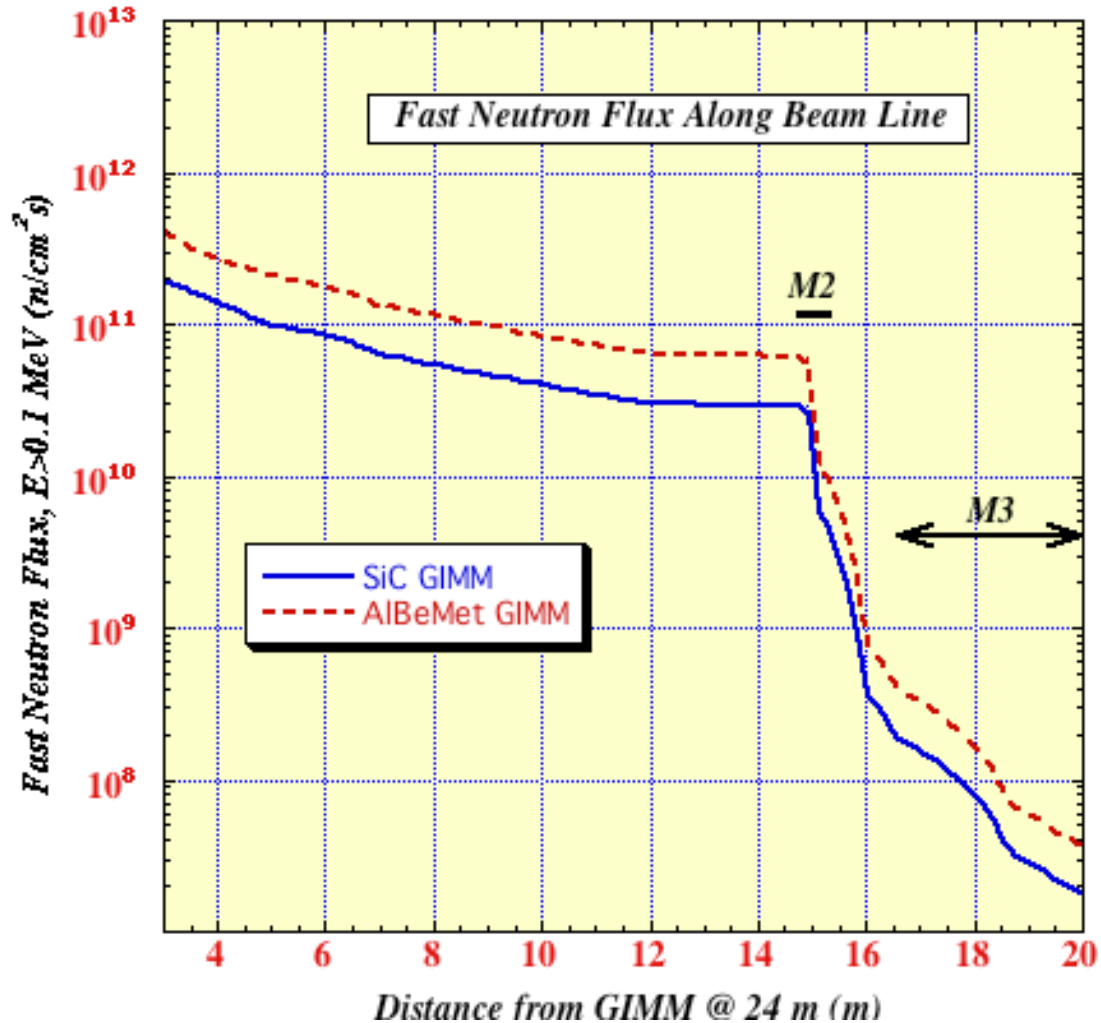

- Neutron flux higher by factor of ~ 2 with AlBeMet GIMM due to larger thickness and neutron multiplication in Be
- Significant drop in flux at beamline bend around M2
- Peak fast neutron flux at M3 ~ 2 orders of magnitude lower than that at M2

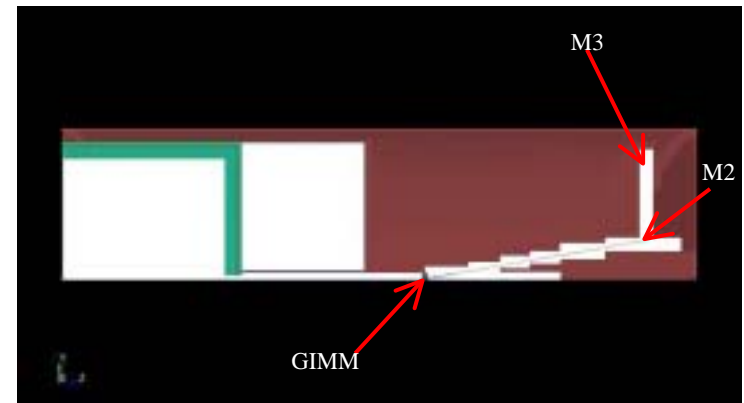

Neutron Spectrum Along Beamline

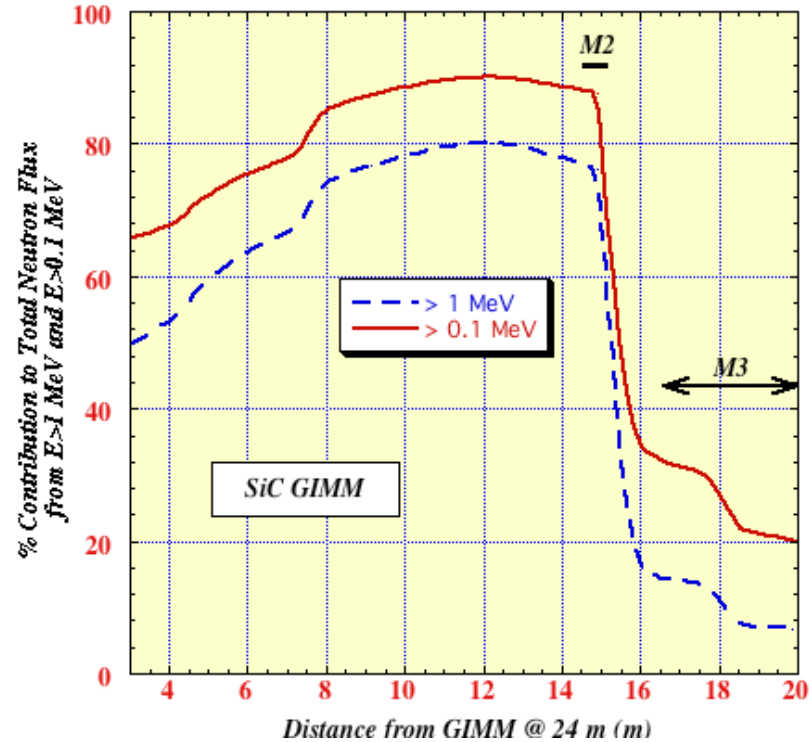
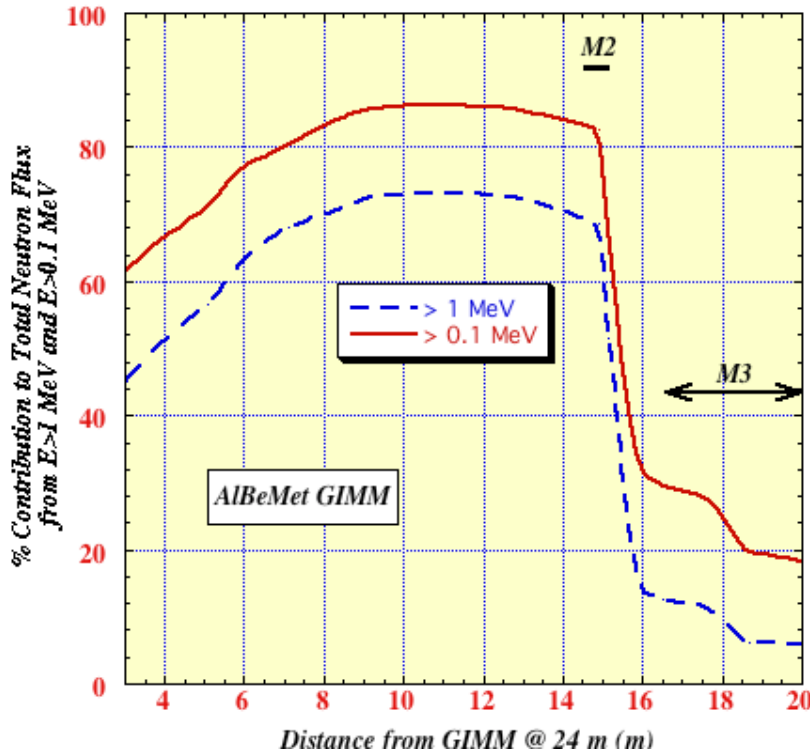

- Neutron spectrum gets harder in part of beam duct approaching M2 (not in direct view of GIMM neutron trap)
- Neutron spectrum softens significantly at M3
- Neutron spectrum slightly harder with SiC GIMM

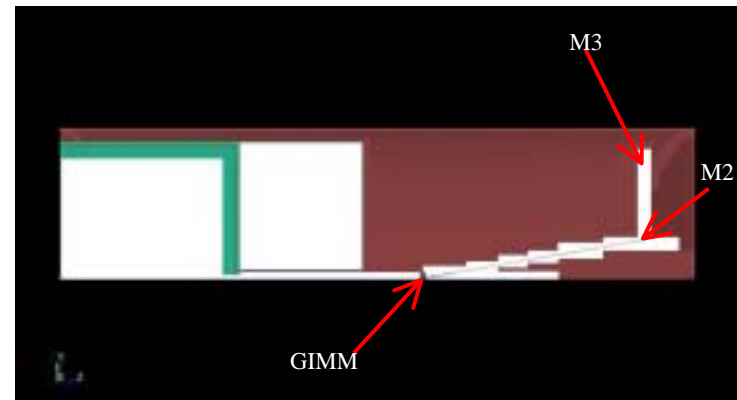

Gamma Flux Along Beamline

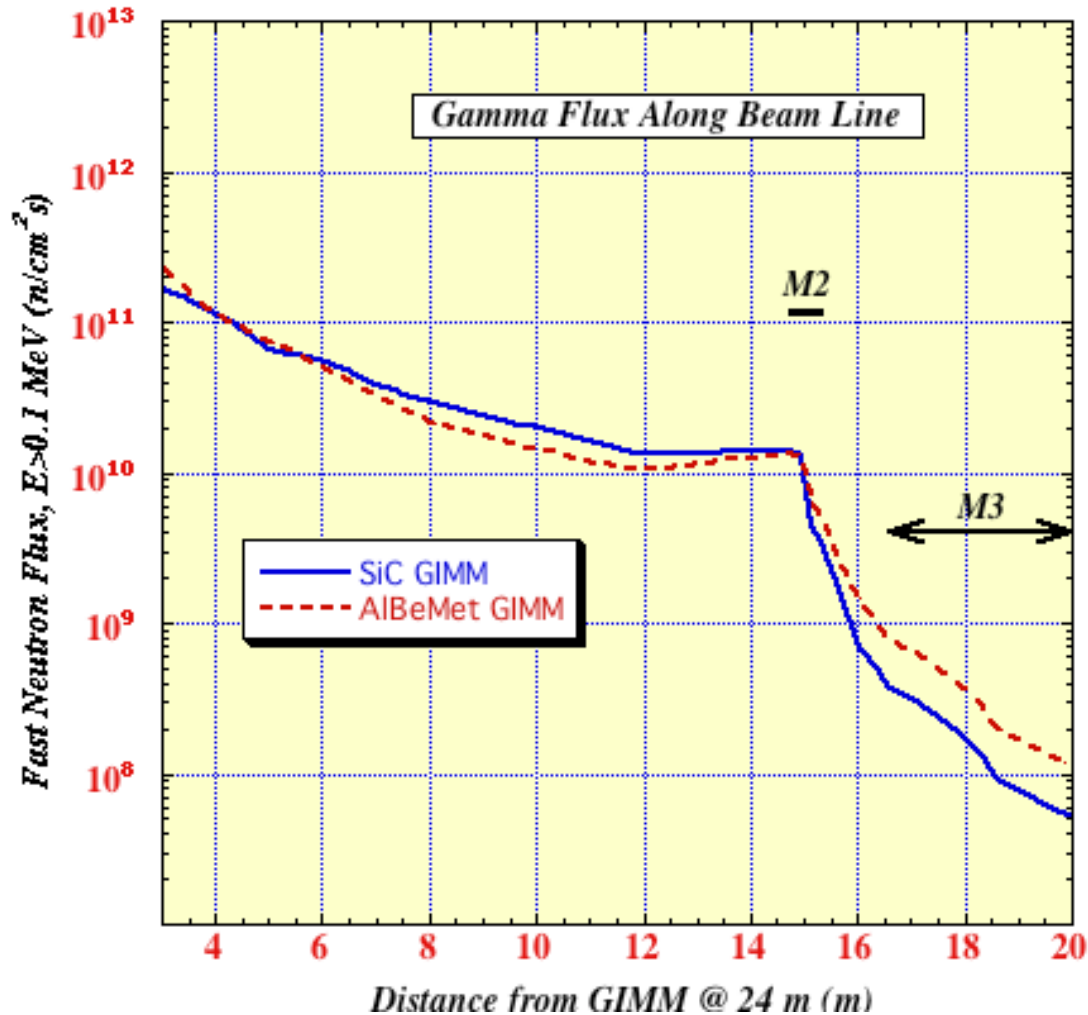

- Gamma flux comparable up to M2 due to dominant contribution from GIMM but is higher at M3 with AlBeMet GIMM
- Significant drop in flux at duct bend around M2
- Peak gamma flux at M3 ~ an order of magnitude lower than that at M2

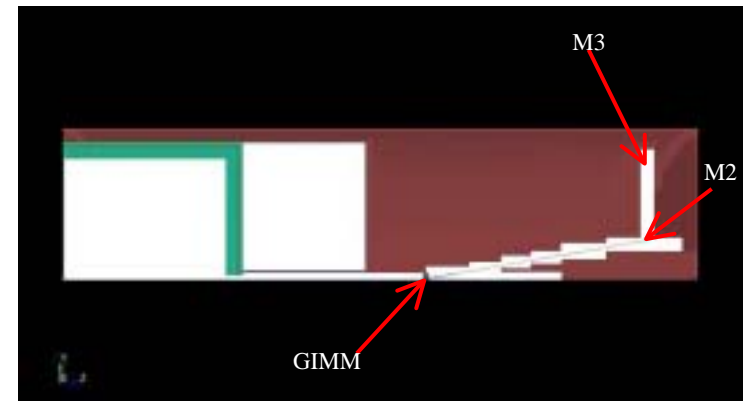

Flux at Dielectric Mirrors M2 and M3

		Flux @M2 (cm ⁻² s ⁻¹)	Flux @M3 (cm ⁻² s ⁻¹)
SiC GIMM	Neutrons E>1 MeV	2.48x10 ¹⁰	9.00x10 ⁷
	Neutrons E>0.1 MeV	2.85x10 ¹⁰	2.01x10 ⁸
	Total Neutrons	3.25x10 ¹⁰	6.23x10 ⁸
	Total Gamma	1.41x10 ¹⁰	4.02x10 ⁸
AlBeMet GIMM	Neutrons E>1 MeV	5.06x10 ¹⁰	1.79x10 ⁸
	Neutrons E>0.1 MeV	6.10x10¹⁰	4.23x10⁸
	Total Neutrons	7.38x10 ¹⁰	1.43x10 ⁹
	Total Gamma	1.34x10¹⁰	8.35x10⁸

- Neutron flux a factor of ~2 higher with AlBeMet
- Total neutron and gamma fluxes @M2 are more than two orders of magnitude lower than at GIMM
- Fast neutron flux @M3 is about two orders of magnitude lower than at M2 with smaller gamma flux reduction
- Neutron spectrum softens significantly at M3 (~30% >0.1 MeV) compared to ~85% at M2

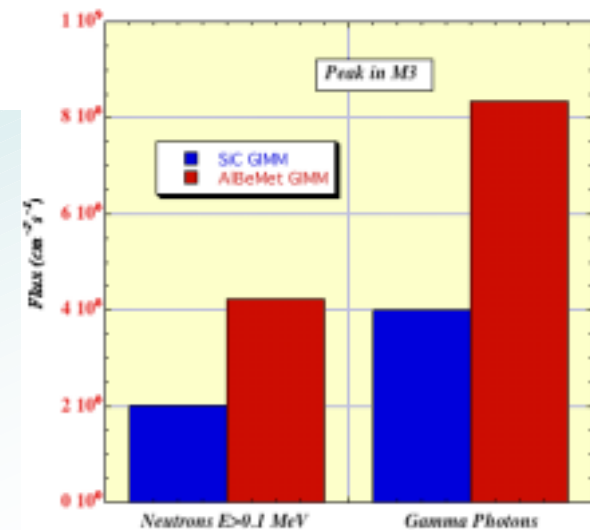
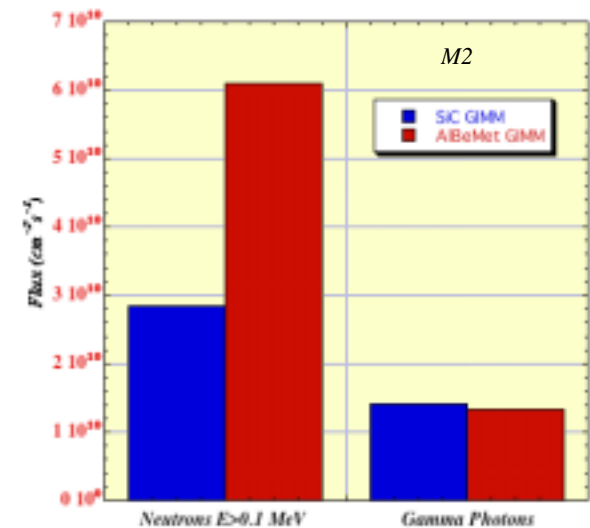

Detailed 3-D Analysis for Final Optics

- Detailed 3-D model developed and tested for MCNP-CGM calculations
- One duct modeled with reflecting boundaries
- All 3 mirrors and accurate duct shape included

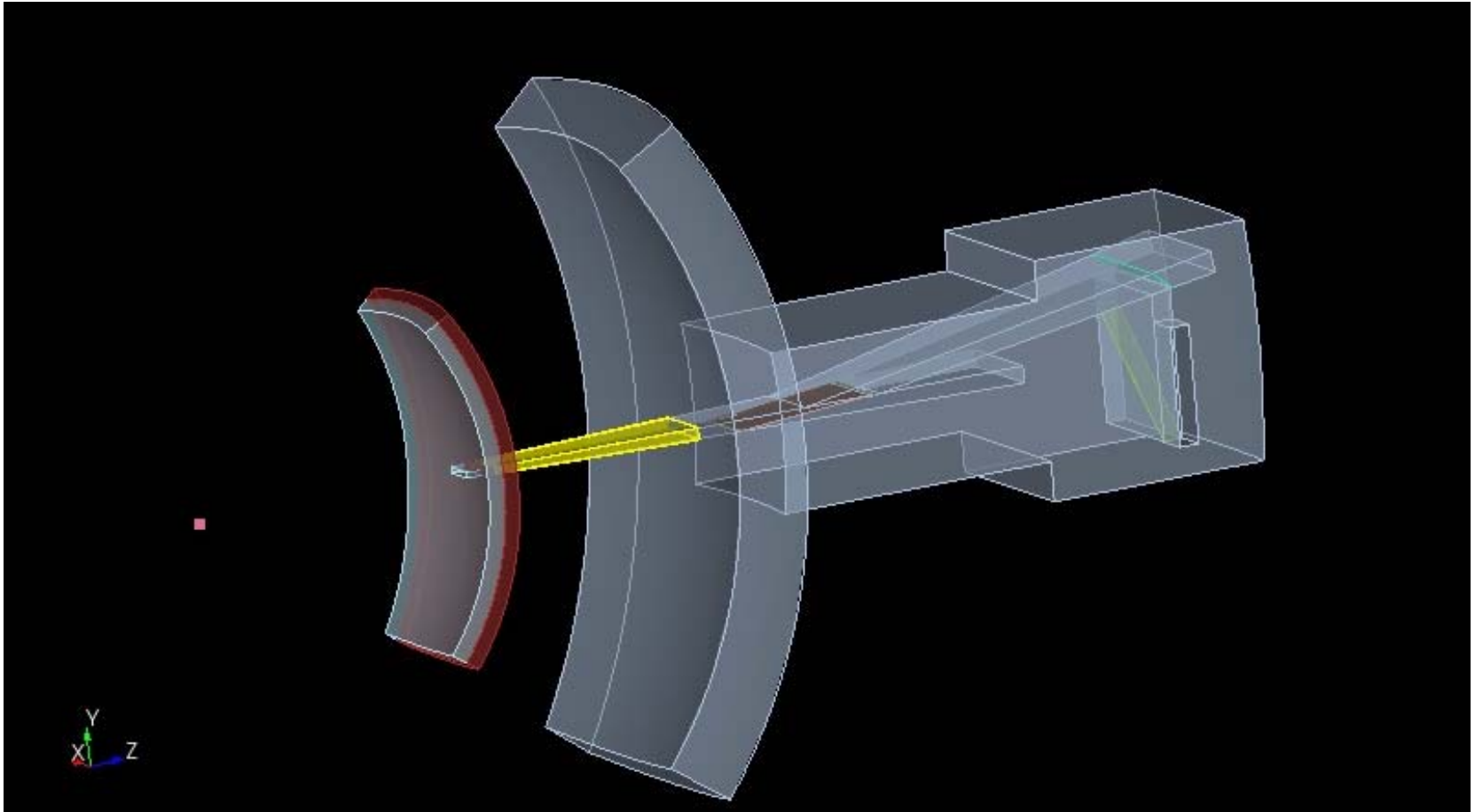

Summary and Conclusions

- 2-D neutronics calculation performed to compare impact of GIMM design options and duct lining on radiation environment
- Lining beam ducts with materials rich in hydrogen and boron (boron hydride, borated polyethylene) have best impact on fast neutron flux
- Effect is small (<4%) at M2 and does not justify design complexity
- Neutron flux at GIMM is higher for AlBeMet and gamma flux is higher for SiC
- Neutron flux at dielectric mirrors is higher by a factor of ~2 with AlBeMet
- Neutron spectrum softens significantly at M3 (~30% >0.1 MeV vs. ~85% at M2)
- Peak fast ($E > 0.1$ MeV) neutron fluence per FPY:

<i>GIMM</i>	$4.9 \times 10^{20} \text{ n/cm}^2\text{s}$
<i>M2</i>	$1.92 \times 10^{18} \text{ n/cm}^2\text{s}$
<i>M3</i>	$1.34 \times 10^{16} \text{ n/cm}^2\text{s}$
- Significant drop in nuclear environment occurs as one moves from the GIMM to dielectric focusing and turning mirrors
- Experimental data on radiation damage to metallic and dielectric mirrors are essential for accurate lifetime prediction
- Developed model for 3-D neutronics of final optics to confirm findings

